



Wenzhou Safewire Electric Co.,Ltd.
No.152 Xingguang Road, Xingguang industry zone, Liushi town, Yueqing, Wenzhou,China ,325604
Tel:0086-577-62799688; Email:info@safewirele.com;
www.safewirele.com

Wenzhou Safewire Electric CO.,Ltd.

SPECIFICATION SHEET

PRODUCT NAME: Open cover floor socket

PRODUCT No. : FD-777



FD-777

ADD: 152 xinguang industrial zone, yueqing city, zhejiang province
(TEL) :0086-577-62799688
(E-mail) : info@safewirele.com
(WEB): <http://www.safewirele.com>



Wenzhou Safewire Electric Co.,Ltd.

No.152 Xingguang Road, Xingguang industry zone, Liushi town, Yueqing, Wenzhou,China ,325604
Tel:0086-577-62799688; Email:info@safewirele.com;

www.safewirele.com

Technical parameters & characteristic :

1) Working environment:

1. The environment temperature:-5°C~/40°C
2. The rated voltage : 100V~~250V
3. Rated current : 10A、 13A、 16A、 20A

2) Characteristic:

1	Model	FZ-531	6	HS Code	8536690000
2	Brand Name	Safewire or OEM brand	7	Market standard	Customized
3	Type	Desktop socket	8	Place of origin	Zhejiang , Wenzhou, China
4	Color	Silver/black/white	9	Frequency	50Hz~60Hz
5	Grounding	Standard grounding	10	Current Type	AC

3) Technical parameters :

Serial No.	Parameter	Description
1	Item	FD777
2	Application:	Residential ,Industrial or public
3	Panel Material	Brass alloy
4	Color:	Golden, sliver, black, red, etc
5	Surface finish	Wire drawing/Polishing/Spray painting
6	Grounding:	Standard Grounding
7	Damping device (DP):	Only normal Pop-up without damping device
8	Available modules:	Type 45*45mm series
9	Panel Dimension(mm)	143*136
10	Cutout(mm)	120x120
11	Capacity of modules /Interface size	4 ways modules
12	Bracket material	Zinc Alloy & Alu Alloy
13	Sink box Material	Steel+Zinc plated
14	Sink box Thickness:	Ga steel/1.2mm
15	IP Rating	IP Rated 55
16	Static Pressure force	Over 1000N

Application:

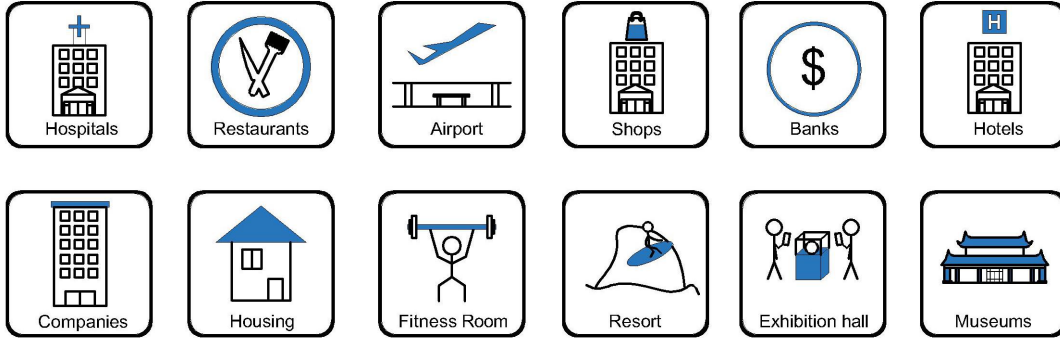

- Office and education
- Industry and Engineering
- Presentation and retail;
- Orientation and safety;
- Transit areas and parking;
- Hotels, hospitality and wellness;
- Health, sport and leisure;
- Art and culture;

CE certificate by TUV,Germany

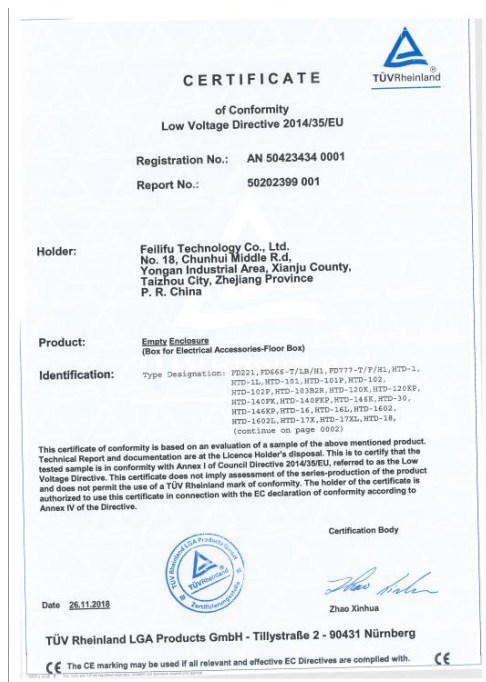

LVD test report

TEST REPORT	
Report No.....	50202399 001
Applicant's name.....	Fellifu Technology Co., Ltd.
Applicant's address.....	No. 18, Chunhui Middle Road, Yongan Industrial Zone, Xianju County, Taizhou City, Zhejiang Province, China
Sample description.....	Empty Enclosure (Box for Electrical Accessories-Floor Box)
Model.....	HTD-1, HTD-1L, HTD-101, HTD-101P, HTD-102, HTD-102P, HTD-10382R, HTD-120K, HTD-120KP, HTD-140FK, HTD-140FKP, HTD-146K, HTD-146KP, HTD-16, HTD-16L, HTD-1602, HTD-1602L, HTD-17X, HTD-17XL, HTD-18, HTD-18L, HTD-180K, HTD-180KP, HTD-2, HTD-2P, HTD-210CK, HTD-210CKP, HTD-26, HTD-26L, HTD-28, HTD-28L, HTD-3, HTD-3P, HTD-30, HTD-40, HTD-71, HTD-71L, HTD-140YK, HTD-140YKP, FDZ21, FD466-TL, BPH1, FD777-TFFH1
Date of receipt of test item.....	Refer to cover page
Test location.....	Room 02, The 2nd floor No.201, GRG Technological Building, 163 Ping Yun Rd, Tianhe District, Guangzhou, China
Test standard.....	EN 60670-23:2008 in conjunction with EN 60670-1:2005
Test date(s).....	Refer to cover page
Test result.....	The test results are in compliance with the above mentioned standards.
Date of issue.....	Refer to cover page
Other aspects:	/
N/A	
Abbreviations: P = passed; F = failed; N/A = not applicable	



Wenzhou Safewire Electric Co.,Ltd.

No.152 Xingguang Road, Xingguang industry zone, Liushi town, Yueqing, Wenzhou,China ,325604
Tel:0086-577-62799688; Email:info@safewirele.com;

www.safewirele.com



Test Report

Applicant : Wenzhou Safewire Electric Co., Ltd.

Address : No.152 Xinggua Road, Xinggua industry zone, Liushi town, Yueqing, Wenzhou, China, 325604

Manufacture : Wenzhou Safewire Electric Co., Ltd.

Address : No.152 Xinggua Road, Xinggua industry zone, Liushi town, Yueqing, Wenzhou, China, 325604

Factory : Wenzhou Safewire Electric Co., Ltd.

Address : No.152 Xinggua Road, Xinggua industry zone, Liushi town, Yueqing, Wenzhou, China, 325604

Product Name : Waterproof floor socket

Model/Type : FD-777

Received Date : April 02, 2019

Testing Period : April 02, 2019- April 03, 2019

Test Summary

No.	Test Item	Test Standard	Test Conclusion
1	IP55 Test	IEC 60529: 2013	Pass

Note:
Pass: Meet the requirements;
Fail: Do not meet the requirements;
N/A: Do not evaluate or provide only test results.

Tested by: Sup zhu
Sup Zhu
Tested engineer

Reviewed by: Eddie Yang
Eddie Yang
Reviewed engineer



Product Show:























Features:

- 1.Protect stumbling: Flush mounting on floor and protect children stumbling
- 2.IP55 :Connected with power supply over IP55 level.
- 3.Rotating modules mechanism: more plug top clearance.Furthermore, enhance lifetime receptacle .
- 4.Soft silica seal cable exit: Protect cable exit from scratching from cover plate of floor boxes.

Available for F type 45*45mm type or D type22.5*45mm international sockets or modules types:

SAFEWIRE

45 Type Function Accessories

								
F2	F3	F4	F11	F15	F16	F18		
								
F20/F21/F22/F23/F25/F28	F50	F51	F52	F53	F55	F56	F58	F59
								
F60	F62	F65/F66/F67/F68	F68	F71				



Wenzhou Safewire Electric Co.,Ltd.

No.152 Xingguang Road, Xingguang industry zone, Liushi town, Yueqing, Wenzhou,China ,325604
Tel:0086-577-62799688; Email:info@safewirele.com;

www.safewirele.com

FD777 Outline drawing:

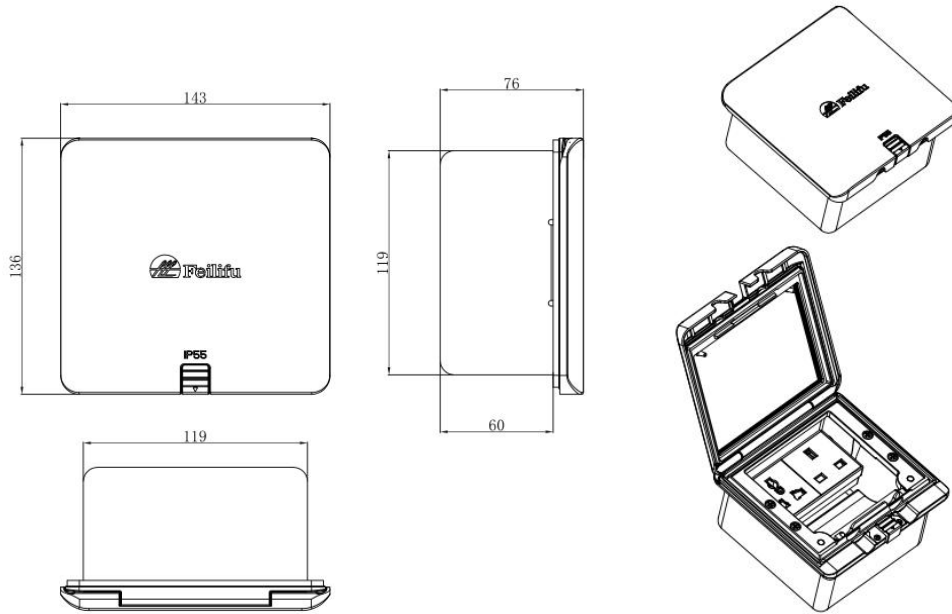

Package:12 Pcs inner box into a master carton.Poly bag with box packing.

SafeWire

Package solution

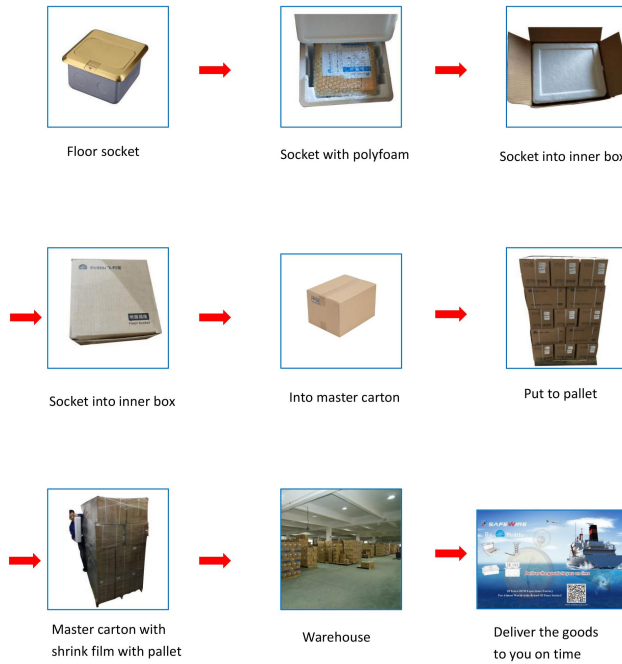

www.safewirele.com



Wenzhou Safewire Electric Co.,Ltd.

No.152 Xingguang Road, Xingguang industry zone, Liushi town, Yueqing, Wenzhou,China ,325604
Tel:0086-577-62799688; Email:info@safewirele.com;

www.safewirele.com

Installation instructions:

1. Remove the panel from the bottom box along with the electrical modules.
2. Fix the flooring with spare screws on the bottom box and place it in the embedded hole.
3. The flooring surface shall be at least level with the ground or 20mm below the ground.
4. Remove flooring surface ,Insert the 10--12mm lead head into the terminal of floor box.
5. Fix the panel to the bottom box with screws.

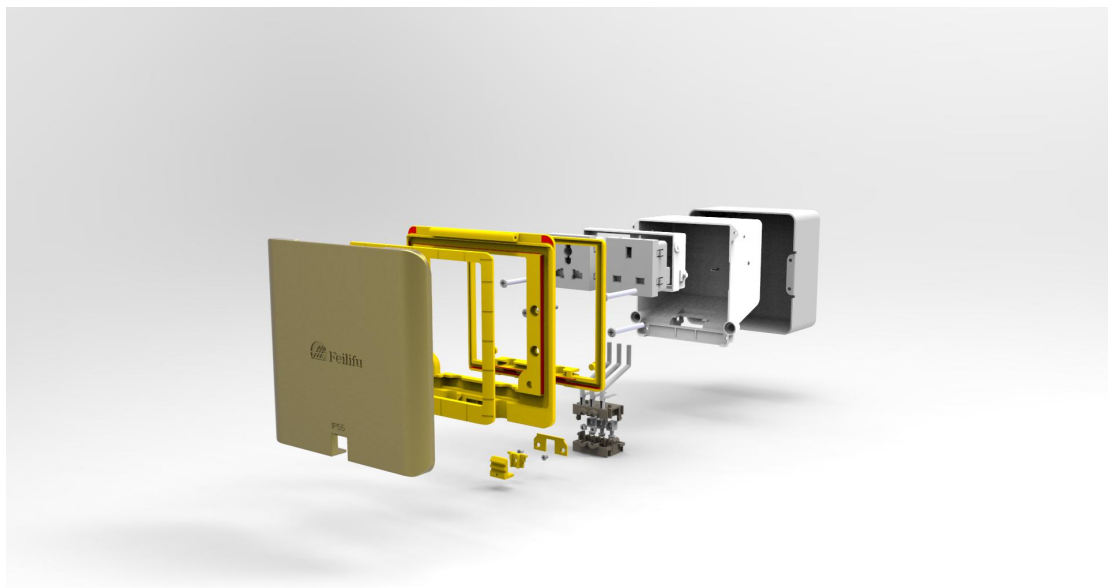
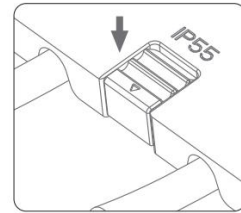
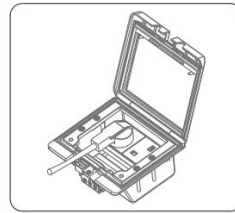
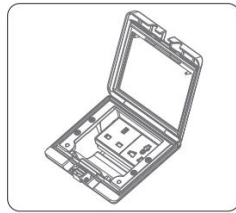
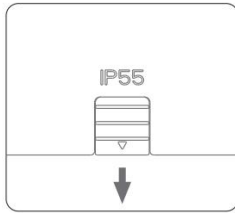



Wenzhou Safewire Electric Co.,Ltd.

No.152 Xingguang Road, Xingguang industry zone, Liushi town, Yueqing, Wenzhou,China ,325604
Tel:0086-577-62799688; Email:info@safewirele.com;

www.safewirele.com

Attentions:

1. Dispose of trash in bottom box and prevent dirt and debris from entering inside.
2. The sealing ring is closely attached to the smooth surface to prevent water leakage.
3. Prevent from alkaline corrosion and humidity.
4. When installing, pay attention to the opening direction,the length of the conductor to the bottom box shall not exceed 10cm,Set aside at least 200mm of cable.
5. When installing and wiring,Product should avoid direct contact with corrosive liquid, gas (strong acid, strong alkali, paint).
6. This product is suitable for dry surface treatment, avoid water flush and immersion, and ensure its insulation
7. Avoid acid alkaline solution flushing,avoid scratch of transparent protective paint,ensure corrosion resistance.

Advantages :

- 1.More Strong Scratch Resistance: Surface finish made from stainless steel or Brass by combination of tough material, Aluminum (ADC12) and shot blast finish on the surface achieves high scratch resistance.Stastic pressure over 1000N.
2. More higher IP protection: Reach IP55 protection level.As per IEC60529/EN60529 for low voltage device safety standards, IP55 mean the first digital No. of “ 5” for dust-tight enclosure protect this dust no more than diameter of 1mm entry and the second digital number of “5” for protect waterproof for splash entry into.
3. High quality socket receptacle:Using elastic phosphor copper avoids playing spark plug and plug set to bit dead ,ensure high conductivity and more life of pulling and plugging over 15000 times.PC+ABS(1.Modules fireproof : 850 degree C temp.; 2.Modules don't distortion under 102 degree C temp.; 3.Stand under 15 degree C temp) ;Oxygen Insulation & Fire resistance in accordance with UL94 international standard.
4. Edible silicone gaskets with service life up to 10 years.
5. Long lifetime of push button: More than 5000 times of push button.
6. More heavy duty of bottom boxes:Thickness of bottom boxes is over 1mm.