



Wenzhou Safewire Electric Co.,Ltd.
No.152 Xingguang Road, Xingguang industry zone, Liushi town, Yueqing, Wenzhou,China ,325604
Tel:0086-577-62799688; Email:info@safewirele.com;
www.safewirele.com

Wenzhou Safewire Electric CO.,Ltd.

SPECIFICATION SHEET

PRODUCT NAME: Desktop socket

PRODUCT No. : FZ-536



FZ-536

ADD: 152 xingguang industrial zone, yueqing city, zhejiang province
(TEL) :0086-577-62799688
(E-mail): info@safewirele.com
(WEB): <http://www.safewirele.com>



Wenzhou Safewire Electric Co.,Ltd.

No.152 Xingguang Road, Xingguang industry zone, Liushi town, Yueqing, Wenzhou,China ,325604
Tel:0086-577-62799688; Email:info@safewirele.com;

www.safewirele.com

Technical parameters & characteristic :

1) Working environment:

1. The environment temperature:-5°C~/40°C
2. The rated voltage : 100V~~250V
3. Rated current : 10A、 13A、 16A、 20A

2) Characteristic:

1	Model	HTD-521	6	HS Code	8536690000
2	Brand Name	Safewire or OEM brand	7	Market standard	Customized
3	Type	floor socket	8	Place of origin	Zhejiang , Wenzhou, China
4	Color	Golden, silver	9	Frequency	50Hz~60Hz
5	Grounding	Standard grounding	10	Current Type	AC

3) Technical parameters :

Serial No.	Parameter	Description
1	Panel Material	Aluminum alloy
2	Surface finish	Electroplated/Painted/Power sprayed
3	Panel Dimension(mm)	220*110
4	Cutout(mm)	201x90
5	Height of product(mm)	85
6	Bottom box size(mm)	200*86*76
7	Bottom box material	Plastic
8	Capacity of modules /Interface size	6 ways
9	Configuration	Power outlet+Data outlet or USB charging : Customized as required
10	Cable length	1.5m, 2m,2m or required length
11	Available modules:	45*45mm Type series

Application :

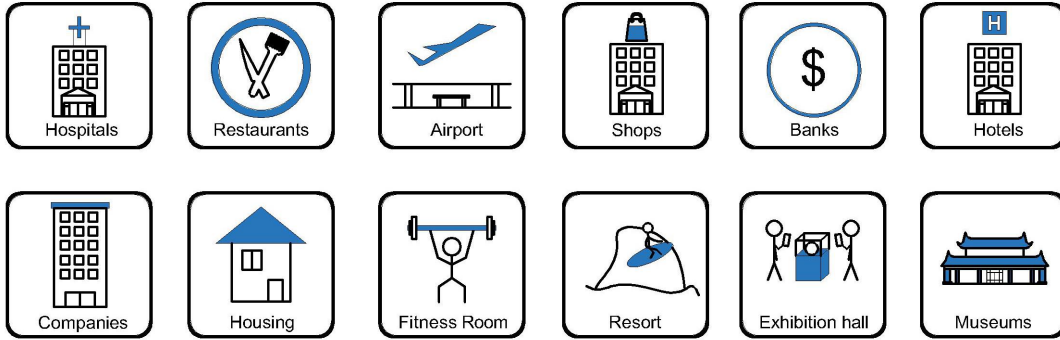

- Office and education
- Industry and Engineering
- Presentation and retail;
- Orientation and safety;
- Transit areas and parking;
- Hotels, hospitality and wellness;
- Health, sport and leisure;
- Art and culture;

CE certificate by TUV,Germany



CERTIFICATE
of Conformity
Low Voltage Directive 2014/35/EU

Registration No.: AN 50423468 0001
 Report No.: 50202406 001

Holder: Feilifu Technology Co., Ltd.
 No. 18, Chunhui Middle R.d,
 Yonggan Industrial Area, Xianju County,
 Taizhou City, Zhejiang Province
 P. R. China

Product: Empty Enclosure
 (Box for Electrical Accessories-Desktop)

Identification: Type Designation: FZ501-D, FZ501-N, FZ510-D, FZ510-N, FZ525-N,
 FZ515-DZ, FZ515-NZ, FZ517-DZ, FZ517-NZ,
 FZ518-DZ, FZ518-NZ, FZ507-D, FZ507-N,
 FZ528-D, FZ528-N, FZ521-D, FZ521-N, FZ536-D,
 FZ531A-D, FZ531B-D, FZ532A-D, FZ532B-D
 Serial No. : Engineering Samples
 Remark: Refer to test report 50202406 001 for details

This certificate of conformity is based on an evaluation of a sample of the above mentioned product. Technical Report and documentation are at the Licence Holder's disposal. This is to certify that the tested sample is in conformity with Annex I of Council Directive 2014/35/EU, referred to as the Low Voltage Directive. This certificate does not imply assessment of the series-production of the product and does not permit the use of a TÜV Rheinland mark of conformity. The holder of the certificate is authorized to use this certificate in connection with the EC declaration of conformity according to Annex IV of the Directive.

Certification Body



 Zhao Xinhua

Date 26.11.2018

TÜV Rheinland LGA Products GmbH - Tillystraße 2 - 90431 Nürnberg

CE The CE marking may be used if all relevant and effective EC Directives are complied with. CE

LVD test report



Page 2 of 21 Report No.: 50202406 001

TEST REPORT

Report No.:	50202406 001
Applicant's name:	Feilifu Technology Co., Ltd.
Applicant's address:	No.18, Chunhui Middle Road, Yonggan Industrial Zone, Xianju County, Taizhou City, Zhejiang Province, China
Sample description:	Empty Enclosure (Box for Electrical Accessories-Desktop)
Model:	FZ501-D, FZ501-N, FZ507-D, FZ507-N, FZ510-D, FZ510-N, FZ515-DZ, FZ515-NZ, FZ517-DZ, FZ517-NZ, FZ518-DZ, FZ518-NZ, FZ528-D, FZ528-N, FZ521-D, FZ521-N, FZ525-N, FZ531A-D, FZ531B-D, FZ532A-D, FZ532B-D, FZ536-S
Date of receipt of test item:	Refer to cover page
Test location:	Room 02, The 2nd floor No.201, GRG Technological Building, 163 Ping Yun Rd, Tianhu District, Guangzhou, China
Test standard:	EN 60670-1:2005+A1:2013
Test date(s):	Refer to cover page
Test result:	The test results are in compliance with the above mentioned standards.
Date of issue:	Refer to cover page
Other aspects:	/
Abbreviations:	P = passed; F = failed; N/A = not applicable

Product Show:























Features:

- 1) Open hidden structure: Open pins coverplate when used and the plate is embedded into socket body inside.
 - 2) With plastic bottom boxes;
- Applicable for wide range of 45*45mm modules of power socket and intelnet data.

Available sockets or modules types:

SAFEWIRE

45 Type Function Accessories

								
F2	F3	F4	F11	F15	F16	F18		
								
F20/F21/F22/F23/F25/F28	F50	F51	F52	F53	F55	F56	F58	F59
								
F60	F62	F65/F66/F67/F68	F68	F71				

FZ-536 Outline drawing:

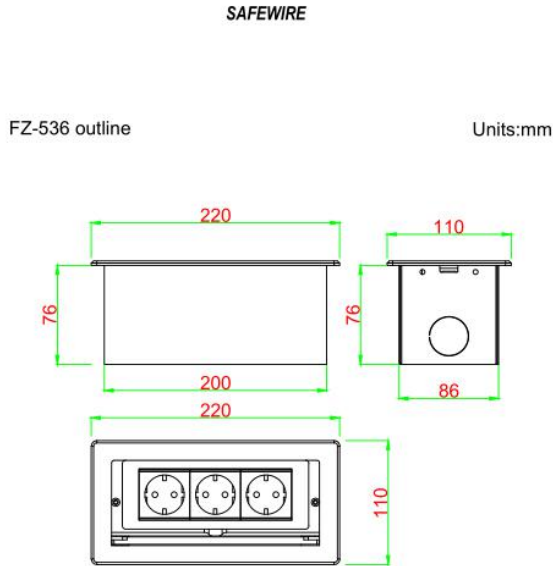

Package:2Pcs inner box into a master carton.Poly bag with box packing.

SafeWire

Package solution

