

Wenzhou Safewire Electric CO.,Ltd.

SPECIFICATION SHEET

PRODUCT NAME: Underfloor Socket

PRODUCT No. : HTD-626AS-120

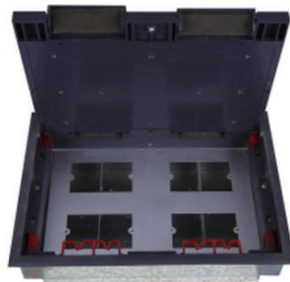

HTD-626AS

Address:2nd floor, Wealth Garden, Liushi town, Yueqing, Wenzhou,China ,325604

Tel:0086-577-61725369

Mob:0086-18612380398

ZIP:325604

(E-mail) : info@safewirele.com

(WEB): <http://www.safewirele.com>

Technical parameters & characteristic :

1) Working environment:

1. The environment temperature:-5°C~/40°C
2. The rated voltage : 100V~~250V
3. Rated current : 10A、 13A、 16A、 20A

2) Characteristic:

1	Model	HTD-626AS	6	HS Code	8536690000
2	Brand Name	Safewire or OEM brand	7	Market standard	Customized
3	Type	floor socket	8	Place of origin	Zhejiang , Wenzhou, China
4	Color	Golden, silver	9	Frequency	50Hz~60Hz
5	Grounding	Standard grounding	10	Current Type	AC

3) Technical parameters :

Serial No.	Parameter	Description
1	Panel materials	Plastic
2	Material	ABS, galvanised steel
3	Overall Frame & Lid (mm)	320.5*230.5
4	Compact floor cut-out(mm)	(305-310)*(210-215)*(76-110)
5	Thickness of concavity/Frame lid recess (mm)	8
6	Installation depth(mm)	70mm~110mm
7	Plug top clearance(mm)	13~38
8	Available modules	4*120 modules
9	Accessories plates	90*80mm
10	G.W.	14.2KG/Carton
11	N.W.	13.2KG/Carton

Application:



Concrete floor feature:

- 1、 The ground is sturdy and not easily damaged. It is durable use.
- 2、 It protects the cable buried in the ground and protects it from human damage.
- 3、 Can reduce the cost of repairing the ground later

Concrete floor requirements for floor socket:



- 1、 No pollution to the environment, no harm to the human body, no toxicity.
- 2、 Easy to install and easy to use, not easy to damage

Features:

- 1、 The lid made of ABS material as per RoHS certification, resistant to high temperature and corrosion. It is environment friendly.
- 2、 **capacity:** HTD-626AS can install 4 ways (120 type socket) .
- 3、 **Thicknes of concavity/Frame lid recess** be 8mm; It can add decorative materials like carpet, parquet or other finishes, on the lid.Integrate the whole into the environment
- 4、 The height of the bottom box reaches 95mm,There is enough space inside the bottom box to install the cable.
- 5、 The static pressure force over 1000 N. Not easy to damage

CE certificate by TUV,Germany

LVD test report

CERTIFICATE		
of Conformity Low Voltage Directive 2014/35/EU		
Registration No.:	AN 50423466 0001	
Report No.:	50202403 001	
Holder:	Feilifu Technology Co., Ltd. No. 18, Chunhui Middle R.d, Yongan Industrial Area, Xianju County, Taizhou City, Zhejiang Province P. R. China	
Product:	Empty Enclosure (Box for Electrical Accessories-Floor Box)	
Identification:	Type Designation: HTD-622AS, HTD-624AS, HTD-624AS (side mounting), HTD-626AS, HTD-628AS Serial No. : Engineering Samples Remark: Refer to test report 50202403 001 for details	
<p><small>This certificate of conformity is based on an evaluation of a sample of the above mentioned product. Technical Report and documentation are at the Licence Holder's disposal. This is to certify that the tested sample is in conformity with Annex I of Council Directive 2014/35/EU, referred to as the Low Voltage Directive. This certificate does not imply assessment of the series-production of the product and does not permit the use of a TÜV Rheinland mark of conformity. The holder of the certificate is authorized to use this certificate in connection with the EC declaration of conformity according to Annex IV of the Directive.</small></p>		
		Certification Body
Date 26.11.2018		Zhao Xinhua
TÜV Rheinland LGA Products GmbH - Tillystraße 2 - 90431 Nürnberg		
<p><small>CE The CE marking may be used if all relevant and effective EC Directives are complied with.</small></p>		

	Page 2 of 19	Report No.: 50202403 001
TEST REPORT		
Report No.	50202403 001	
Applicant's name	Feilifu Technology Co., Ltd.	
Applicant's address	No.18, Chunhui Middle Road, Yongan Industrial Zone, Xianju County, Taizhou City, Zhejiang Province, China	
Sample description: ..	Empty Enclosure (Box for Electrical Accessories-Floor Box)	
Model	HTD-622AS, HTD-624AS, HTD-624AS (side mounting), HTD-626AS, HTD-628AS	
Date of receipt of test item	Refer to cover page	
Test location	Room 02, The 2nd floor No.201, GRG Technological Building, 163 Ping Yun Rd, Tianhe District, Guangzhou, China	
Test standard	EN 60670-23:2008 in conjunction with EN 60670-1:2005	
Test date(s)	Refer to cover page	
Test result	The test results are in compliance with the above mentioned standards.	
Date of issue	Refer to cover page	
Other aspects:	/	
N/A		
Abbreviations: P = passed; F = failed; N/A = not applicable		

Product Show:





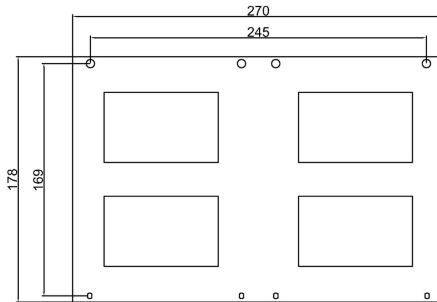

















Our floor boxes can be fitted with various type 86 panels



Available sockets or modules types:

SAFEWIRE

45 Type Function Accessories

								
F2	F3	F4	F11	F15	F16	F18		
								
F20/F21/F22/F23/F25/F28	F30	F31	F32	F33	F55	F56	F58	F59
								
F60	F62	F65/F66/F67/F68	F68	F71				

HTD-626AS Outline drawing:

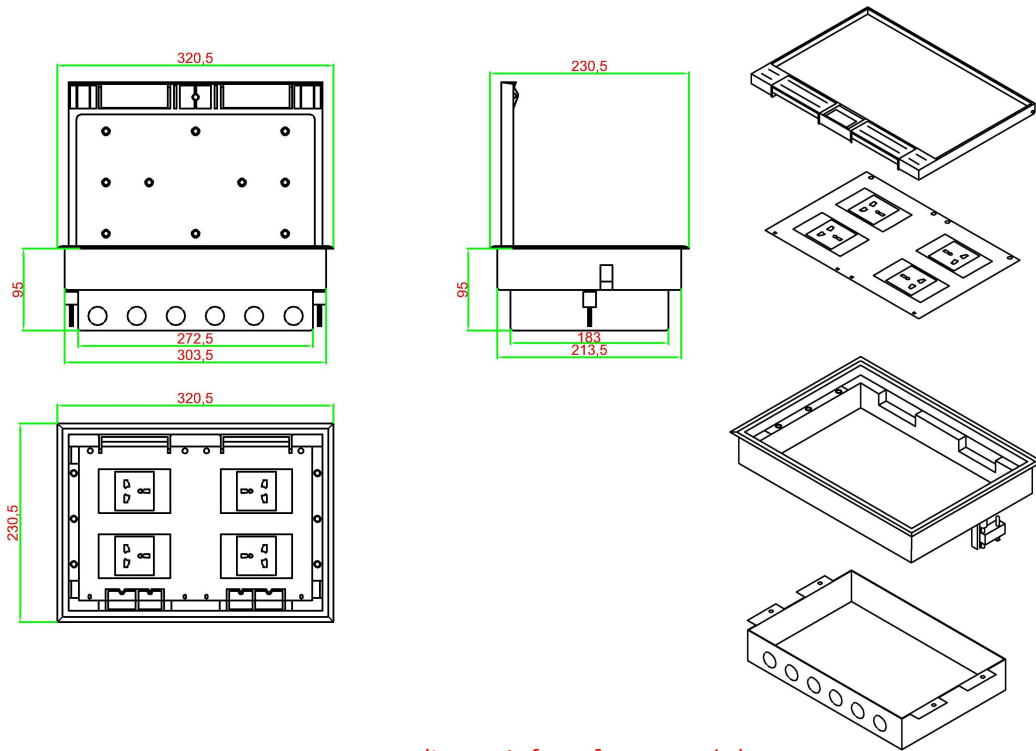

(Image is for reference only.)

Package:4 Pcs inner box into a master carton.Poly bag with box packing.

SafeWire

Package solution



Installation instructions:

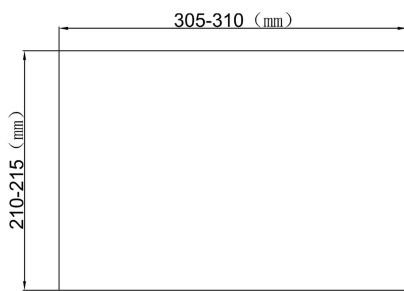

CUT OUT SIZE

Installation depth(mm): 76-110
Plug top clearance(mm): 14-48

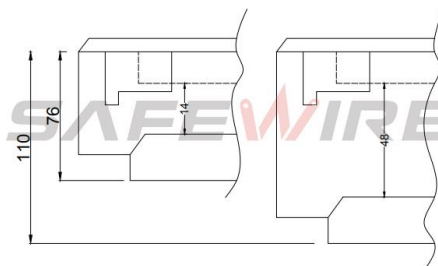

(2)

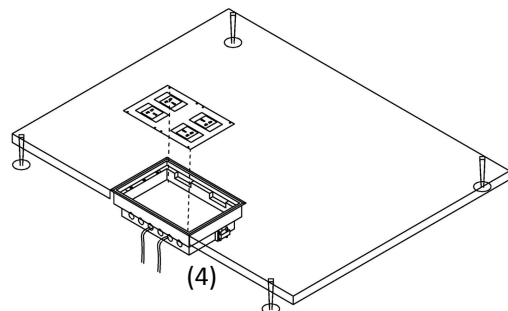
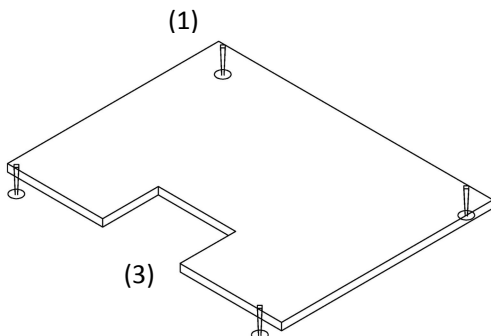

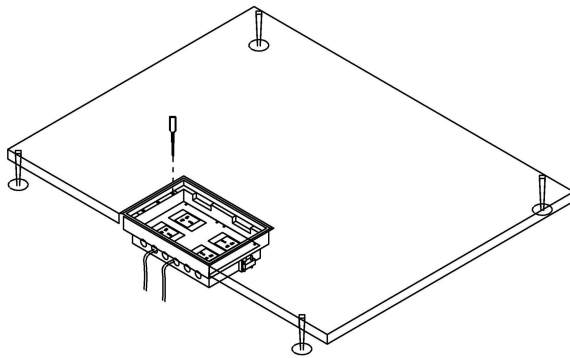

(5)

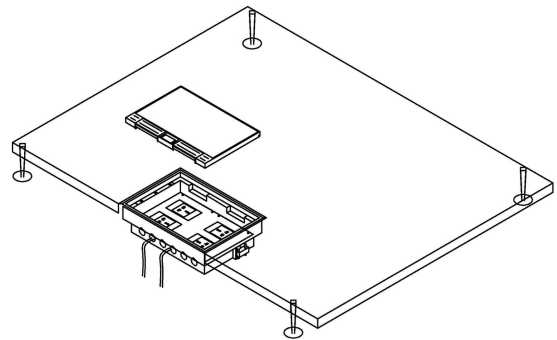

(6)

1.Floor box(For concrete floor)

Align floor box in centre as delivered.Bend open ears and fix to raw ceiling.

2.Steel armored conduit(For trunking system/Access floor).Bend open perforation in the sides of floor box and insert steel armored conduct.

3.Put under floor box into cut out and adjust height(For raised floor) .Put under floor box into hole/location of raised floor.Then move the adjustable screw in clockwise direction until screws are tightened with flooring.lead the lines into plastic bottom box.

4.Installing Heavy current/Data systems

Insert heavy current devices from the top and connect from below and snaptabs into the frame;Insert connected data Jacks from below into the plate,Fasten equipped plate accordingly.

5.Connecting and earthing.

Connect heavy current/Data with the lines which are lead into bottom box.And connect earthing lines of floor cable systems with earthing screw of bottom box torque $> 0.4N.m$.Verify reliable and safe.

6.Assembly and plug into underfloor box.

Inset heavy current and low current plugs into frame.

7.Single outlet

Lead heavy and low current plug cable cord from edge lord outlet lid.

Filling stuff and levelling to floor

Fill the sunken area of panel neatly with filling stuff according surface material of floor .Adjust wnder floor box height flush over the four levelling screws.



Attentions:

- 1.Dispose of trash in bottom box and prevent dirt and debris from entering inside.
- 2.The sealing ring is closely attached to the smooth surface to prevent water leakage.
- 3.When installing, pay attention to the opening direction,the length of the conductor to the bottom box shall not exceed 10cm,Set aside at least 200mm of cable.
- 4.When installing and wiring,Product should avoid direct contact with corrosive liquid, gas (strong acid, strong alkali, paint).
- 5.Please close cover when not used.

Safety Warning:

- 1.This is a class I product and must be earthed
- 2.This product must be installed/wired by a qualified electrician
- 3.For indoor use only.
- 4.For concrete floor/access floor.base on different bottom box.