

Wenzhou Safewire Electric CO.,Ltd.

SPECIFICATION SHEET

PRODUCT NAME: AV Multi-media floorbox

PRODUCT No. : HTD-220-AV



Address:2nd floor, Wealth Garden, Liushi town, Yueqing, Wenzhou,China ,325604

Tel:0086-577-61725369

Mob:0086-18612380398

ZIP:325604

(E-mail) : info@safewirele.com

(WEB): <http://www.safewirele.com>

Quick Details:

Serial No.	Parameter	Description
1	Safewire item	HTD-220-AV
2	Surface finish	Wire drawing/Polishing/Spray painting
3	Panel Dimension(mm)	220*220
4	Cutout(mm)	210*210
5	Capacity of modules	CUSTOMIZATION AV modules
6	Mounting type	Horizontal installation
7	Bracket material	Zinc Alloy & Alu Alloy
8	Sink box Material	Steel+Zinc plated
9	Base box dimension(mm)	110*210*90
10	Available modules	45*45/22.5*45(mm) or 23*36mm

Application:



1.Feature of Safewire floorbox:

1. Customzation design & production: ODM & OEM as per samples or drawing by each of us.



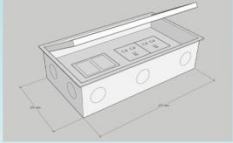

①Dimension

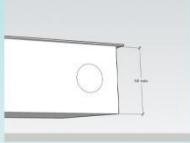

②Height

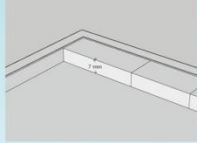

③Cavity(depth)

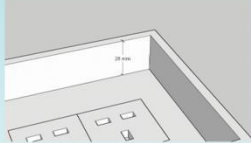

④Plug clearance
(Height of lid to support)

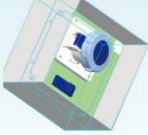

A)MCB + CEE socket





B)45*45mm module socket

COMMSCOPE®

CRESTRON

Extron.





HT-146TS

C)Switch socket



HT-86SS



D)Consigned Electric
Allessores by client Example

2. Supply with SKD parts or finished products, save cost: save cost, save money for you!

Cover Plate



Bottom Box



Bridge & Support:



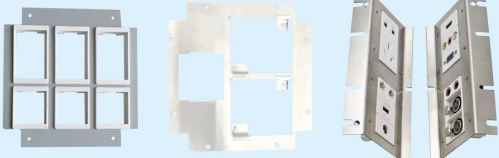

1.45*45mm Modules



2. 128 Type series



3.86/146 Type module socket

45

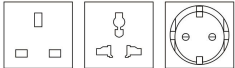

128

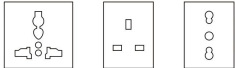

86

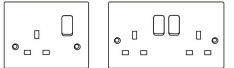

4.5V 4.2A USB charger 、 HDMI 、 Cat6 , RCA , and so on

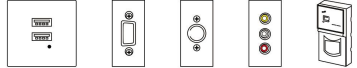

3. Flush-mounting & Recess-mounting in Access floor & Recess floor



Access floor & Heavy duty Recess floor

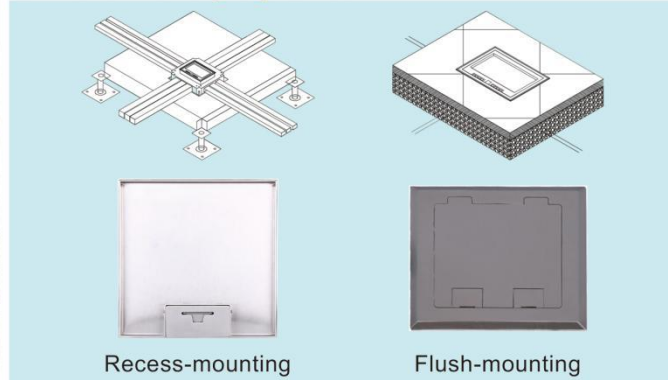

2. Advantage of Safewire floorbox :

1. Patent Retractable cable entry design:



2. More affordable MOQ less than 100 units:



3. More internation socket , multimedia and Data accessories :

1.45*45mm Modules

45

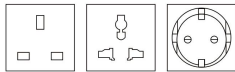

2. 128 Type series

128

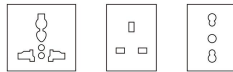

3.86/146 Type module socket

86

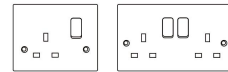

3.Specification of Safewire floorbox :

A)Product dimension:

HTD-220-AV Units:mm

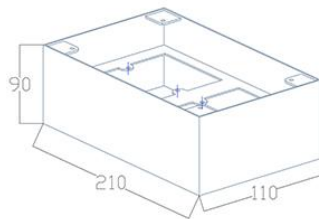

B)Available installation modules/socket/accessories:

1.45*45mm Modules

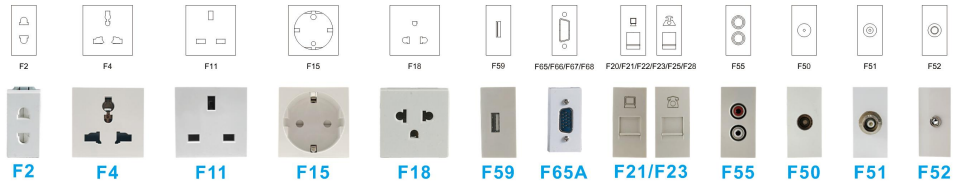





2. BS/UK type switch socket and UKCA and BS7288 certificate RCD switch socket











3. Switch socket



4.128 Type modules socket

	23x72mm	Thailand 6 Pin Power socket	white/black
	23x72mm	NEMA5-15R 16A 6 Pin power socket	white/black
	23x72mm	NEMA5-20R 20A 6 Pin Power socket	white/black
	23*36mm	RJ11 telephone models	white/black

C)FACTA class/EN124 class load of coverplate:

FACTA Class	En124 Class	GLW Gross laden Vehicle Weight (slow moving)	Wheel Loads		Typical Applications	
			Wheel Loads*(slow moving)Pneumatic	Wheel Loads (slow moving) Solid	Pneumatic Tyres	Solid Tyres
	A15	Pedestrian duty	0.6 tonne(5KN)	N/A	Internal and external areas which can only be used by pedestrians or cycles ie. toilets, changing rooms, footways and cycle tracks	
	N/A	5 tonne	1.5 tonne(15KN)	N/A	Very light industrial areas, where small trolleys and private cars/ vans can manoeuvre i.e. Domestic driveways, trolley parks, hospital wards, underground car parks	
	N/A	10 tonne	2.5 tonne(25KN)	0.5 tonne	Delivery/ service areas, shopping malls, light industrial areas	Light industrial areas, where trolleys and light pallet trucks operate
	B125	Up to 44 tonne	5.0 tonne(25KN)	0.75 tonne	Pedestrian precincts, forecourts, commercial delivery/ parking areas	Factories, industrial plants, where pick-up trucks and small pallet trucks operate
	C250	Up to 44 tonne but under special conditions	6.5 tonne(65KN)	1.0 tonne	Factories, industrial plants, special axle loads, kerb side drainage	Industrial areas where pallet and small forklift trucks operate
	D400	Up to 44 tonne but under special conditions	11.0 tonne(108KN)	3.0 tonne	Heavy duty plant areas carriage-ways and industrial service roads where fast moving HGVs reach speeds of 32 km/h max	Heavy duty industrial areas where medium duty fork-lift trucks operate
	E600	Special application vehicles	16.0 tonne(158KN)	5.0 tonne	Dockside and container storage areas where heavy transporters operate	Very heavy industrial areas where large heavy duty fork-lift trucks operate
	F900	Special application vehicles	24.0 tonne(237KN)	N/A	Civil and military airfield aprons, where particularly heavy wheel loads are imposed by aircraft and towing vehicles	

*Slow moving wheel loads are deemed to be speeds no greater than 32 km/h.

D)Safewire floorbox Application in different floor system:

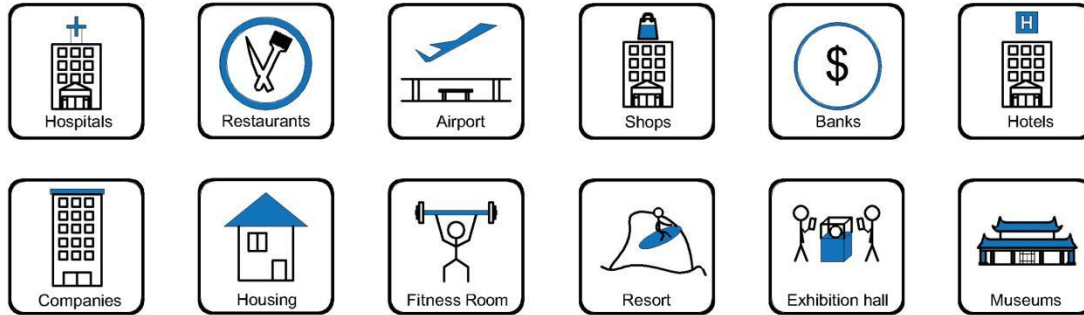

F)Safewire recommended or other solution of requirement :

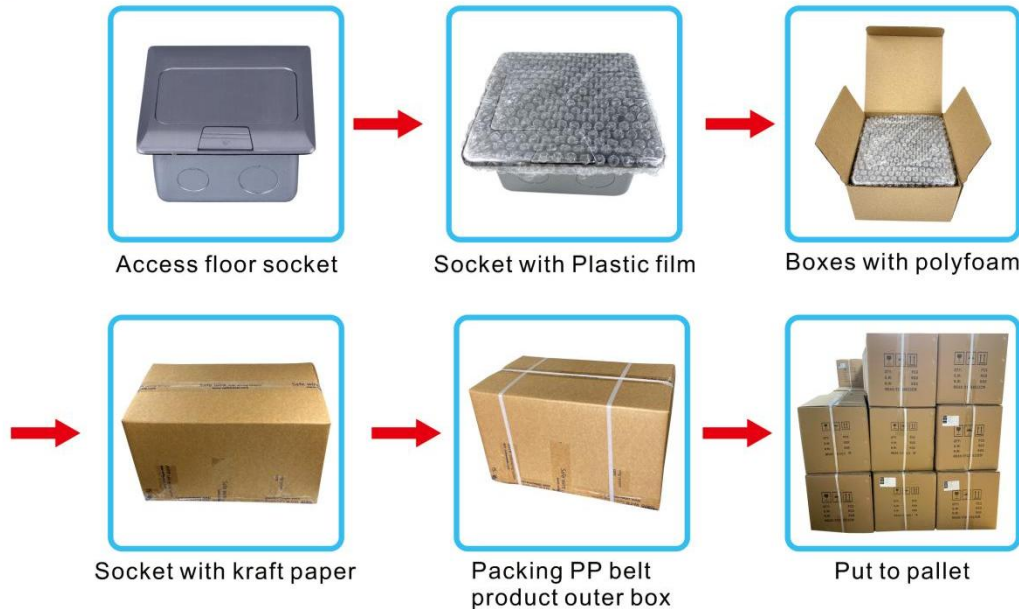

Installation instructions:

1. Cut out 233*233(mm), Powering the slurry.
2. Remove the pre-installed temporary lid,wiring and installing modules.
3. Pre-installed cable pipe as per your request .
4. Install cover lid and tighten with screws.
5. Conceal the cut edge of carpet of flooring

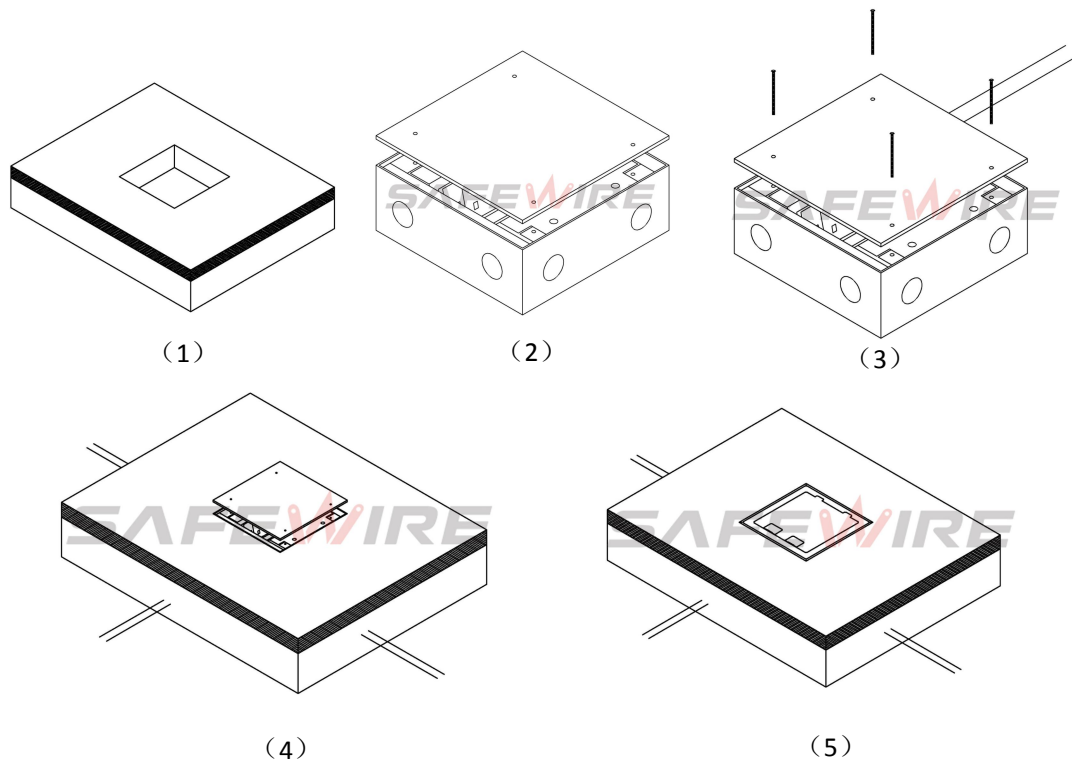



Attentions:

- 1.When installing and wiring,Product should avoid direct contact with corrosive liquid, gas (strong acid, strong alkali, paint).
- 2.This product is suitable for dry surface treatment, avoid water flush and immersion, and ensure its insulation.This product is not suitable for use in wet areas.
- 3.All dimensions quotes are nominal only.Drawing images and specification are only for illustrative purposes and dimensions are subject to final confirmation by us.

Safety Warning:

- 1.This is a class I product and must be earthed
- 2.This product must be installed/wired by a qualified electrician
- 3.For indoor use only.
- 4.For concrete access floor.