



Wenzhou Safewire Electric Co.,Ltd.
2nd floor, Wealth Garden, Liushi town, Yueqing, Wenzhou,China ,325604

Wenzhou Safewire Electric CO.,Ltd.

SPECIFICATION SHEET

PRODUCT NAME: underfloor socket

PRODUCT No. : HTD-624B



Address:2nd floor, Wealth Garden, Liushi town, Yueqing, Wenzhou,China ,325604

Tel:0086-577-61725369

Mob:0086-18612380398

ZIP:325604

(E-mail) : info@safewirele.com

(WEB): <http://www.safewirele.com>

Tel:0086-577-61725369;

Email:info@safewirele.com;

<http://www.safewirele.com>

Technical parameters:

1. The environment temperature: -5°C~40°C
2. The rated voltage : 100V~~250V
3. The rated current : 10A、 13A、 16A、 20A

1	Model	HTD-624B	7	Market standard	Customized
2	Brand Name	Safewire or OEM brand	8	Place of origin	Wenzhou, Zhejiang , China
3	Type	Underfloor box	9	Frequency	50Hz~60Hz
4	Color	Grey,Black	10	Current Type	AC
5	Grounding	Standard grounding	11	For floor thickness	8mm
6	HS Code	8536690000			



Serial No.	Parameter	Description
1	Panel materials	Plastic
2	Material	ABS, galvanised steel
3	Overall Frame & Lid (mm)	245*225
4	Compact floor cut-out(mm)	213*233
5	Thicknes of concavity/Frame lid recess (mm)	8
6	Installation depth(mm)	85
7	Plug top clearance(mm)	13~48
8	Available modules	Side mounting 4 gang 86 type bridge.
9	Stress tolerance	1000N

Application:

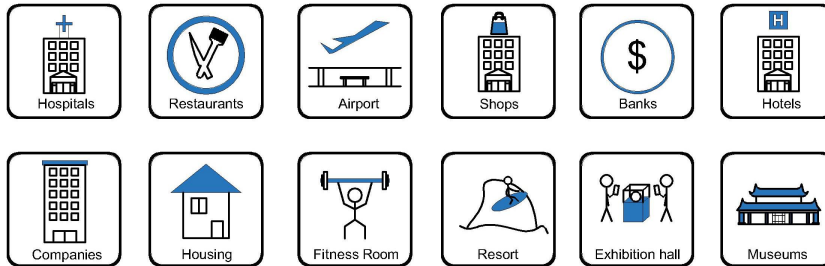

- Office and education
- Industry and Engineering
- Presentation and retail;
- Orientation and safety;
- Transit areas and parking;
- Hotels, hospitality and wellness;
- Health, sport and leisure;
- Art and culture;

Installation instructions:

1. Choose the position of the floor box. It is preferable to keep the tile in its original place, especially if it has been adjusted to its final position.
2. Cut in the center of the tile, we advise 248x248mm square

with a radius of 6mm. An extra 6mm outward in the corners makes the floor box fit perfectly into place. Please keep this hole as small as possible to maintain the maximum carrying capacity of the floor box.

3. Check if the floor box is loosely connected to the lid. The clamp-panels are positioned flat against the box. This way the floor box fits through the hole.

4. Firstly, if RJ45-keystones are applied, remove the two taptite screws keeping the data-panel in place. Then remove the panel from the floor box. Caution: Do not remove the 230V module to maintain the validity of CE.

5. Take all relevant cabling trough the hole in the tile. Then connect the 3-poled plug. If preferred, add a clip for strain relief.

6. Now you can place the floor box through the hole. This is easiestly done if the floor box is kept at an angle. The cabling kept separate above the floor, can now be put through the floor box where the removed panel used to be.

7. Place the keystones in the removed panel. If the cable and keystone are integrated, you can place the keystone and cable

directly into the panel.

8. With the cables in place, they can be fixed to the panel. This is done using a tie-wrap. Use the holes in the rear side of the panel.

9. Place the mounting panel back in its initial position. Use the same taptite screws to fix the panel in place.

10.The floor box is now fully assembled. Make sure the tile is adjusted correctly.

11.Place the carpet or top layer. Use part of the cut-out area of the floor box as inlay. Take pattern direction into consideration if the pattern demands it.

12.Finally tighten the four screws in the lid to fix the floor box to the tile.



Package: 4 Pcs inner box into a master carton. Poly bag with box packing.

Method of use:

Gently press the outlet with your hand and lift the lid ,the lid will open along with it to reveal the function keys inside.(Another way is to open the lid directly to expose the functional module).

Product Show:

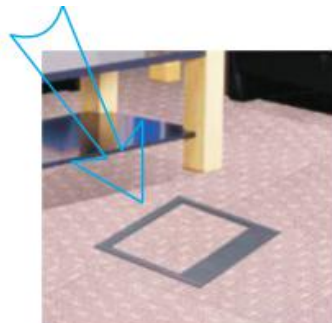

Features:

Our floor boxes are boxes for installation recessed in floor with possibilities of add decorative materials like carpet, parquet or other finishes, on the lid.

1. **Perfect finish:**Our range of access and screed Floor Boxes are available with 1, 2, 3 or 4 compartments and Blends in fully with the surroundings
2. **Safety guaranty:**Frame &lid moulded from high impact ABS plastic material and self-extinguishing, halogen-free materials,guaranty of safety for people and equipment.
3. **Protected opening system:** Easy grip recessed lifting handle and only be opened by pulling both opening clips at the same time. The clips of floor boxes are self-positioning and secure the fastening.
4. **Easy installation:**Clamp fixing of receptacle and Data outlet for fast installation.No junction box is required for installing floor boxes in raised floors.
- 5.**The carpet protective frame is overlapping the edge of the floor and is to protect the carpet material against fraying at the edge.**

HTD-624B Outline drawing

SAFEWIRE

HTD-624B outline



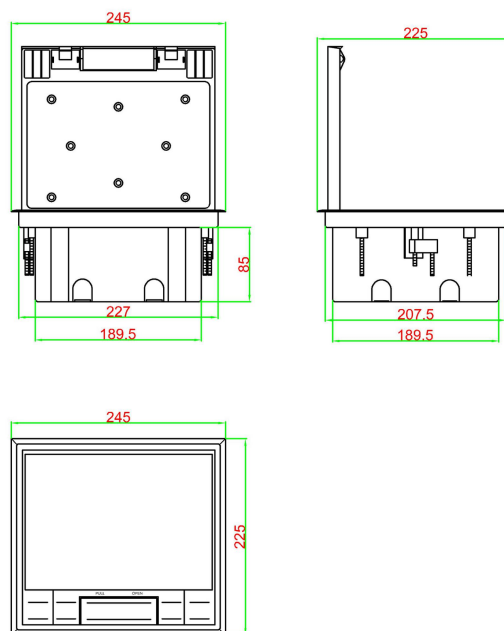

















Units:mm



Available sockets or modules types:

SAFEWIRE

45 Type Function Accessories

								
F2	F3	F4	F11	F15	F16	F18		
								
F20F21F22F23F24F25F26	F30	F31	F32	F33	F35	F36	F38	F39
								
F60	F62	F65F66F67F68	F68	F71				

Installation instructions:

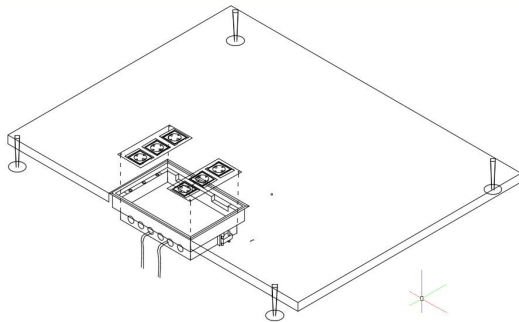

(1)

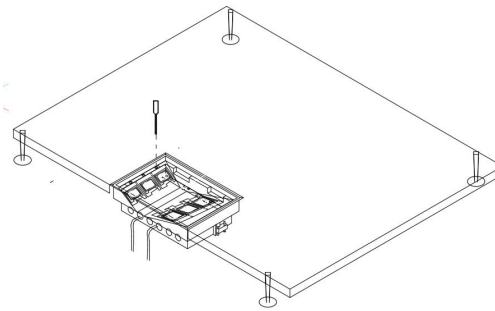

(2)