

Wenzhou Safewire Electric CO.,Ltd.

SPECIFICATION SHEET

PRODUCT NAME: Communication distribution box

PRODUCT No. : SF-dbmz-01



Address:2nd floor, Wealth Garden, Liushi town, Yueqing, Wenzhou,China ,325604

Tel:0086-577-61725369

Mob:0086-18612380398

ZIP:325604

(E-mail) : info@safewirele.com

(WEB): <http://www.safewirele.com>

Quick Details:

Serial No.	Parameter	Description
1	Safewire item	SF-dbmz-01
2	Product Name	Communication distribution box
3	Input	As per requested plug
4	Output	As per requested socket
5	Switch protection	As per requested Switch
6	Size	200*260*120mm
7	Termination	Wire grounding
8	Color	Grey/red (ral2005)

Application:

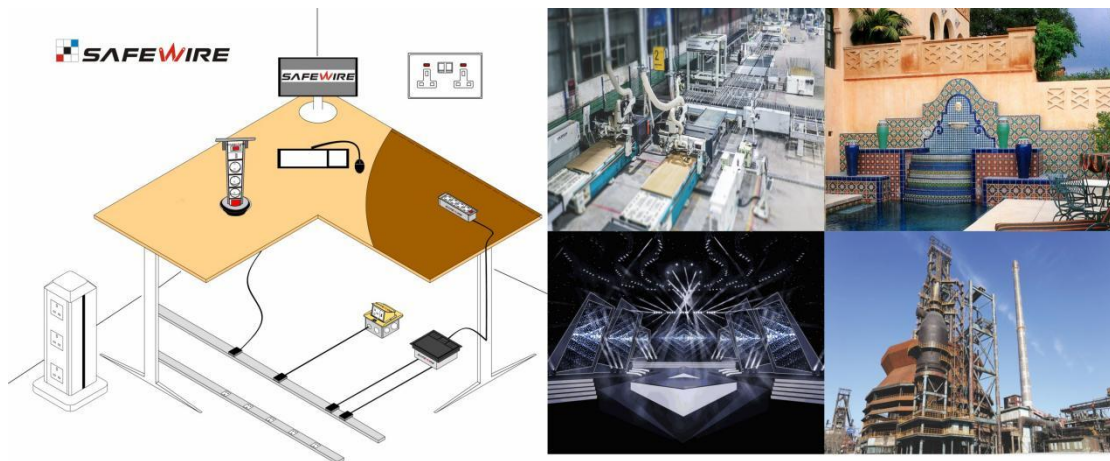

1.Feature of Safewire IP67 portable distribution box:



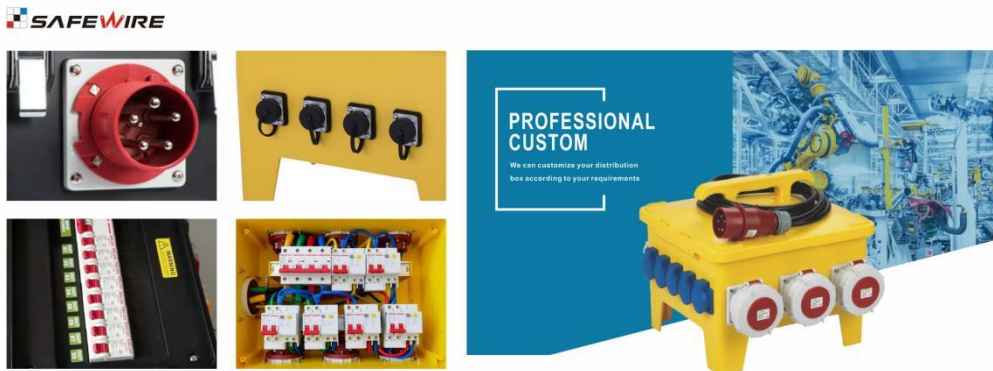













1. Input ,output,shell,protection and hole etc . are customization .



2.Hole as per ODM drawing CNC milling and engraving .



3.Various available socket , plug and RCD and window accessories etc .

<p>Socket</p>	 3pole  4pole  5pole   
<p>Plug</p>	 3pole  4pole  5pole   
<p>RCD&MCB</p>	  
<p>Window Accessories</p>	

2. Advantage of Safewire IP67 portable distribution box:

1. Waterproof IP67 level.



2.Stainless steel clasp,anticorrosion.



3.Higher IK,Impact resistance ,high insulation !



3.Specification of Safewire IP67 portable distribution box:

A)Product dimension:

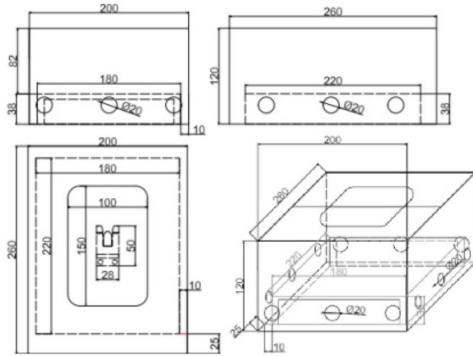

B)Safewire optional of economical package :



Distribution box



Access distribution box



Distribution box in Kraft paper carton



Packing PP belt product outer box



In the big honeycomb box