



Wenzhou Safewire Electric Co.,Ltd.

No.152 Xingguang Road, Xingguang industry zone, Liushi town, Yueqing, Wenzhou,China ,325604

---

Wenzhou Safewire Electric CO.,Ltd.

## SPECIFICATION SHEET

**PRODUCT NAME:**            Open coverplate

**PRODUCT No. :**            HTD-302AL

ADD: 152 xinguang industrial zone, yueqing city, zhejiang province

(TEL) :0086-577-62799688

(E-mail) : info@safewirele.com

(WEB): <http://www.safewirele.com>



### **Technical parameters:**

1. The environment temperature:  $-5^{\circ}\text{C}\sim/40^{\circ}\text{C}$
2. The rated voltage : 100V $\sim\sim$ 250V
3. Rated current : 10A、 13A、 16A、 20A



Wenzhou Safewire Electric Co.,Ltd.

No.152 Xingguang Road, Xingguang industry zone, Liushi town, Yueqing, Wenzhou,China ,325604

<b>1</b>	<b>Model</b>	<b>HTD-302A L</b>	<b>7</b>	<b>Market standard</b>	<b>Customize d</b>
<b>2</b>	<b>Brand Name</b>	Safewire or OEM brand	<b>8</b>	<b>Place of origin</b>	Zhejiang , Wenzhou, China
<b>3</b>	<b>Type</b>	floor socket	<b>9</b>	<b>Frequency</b>	50Hz~60Hz
<b>4</b>	<b>Color</b>	Golden, silver, etc	<b>10</b>	<b>Current Type</b>	AC
<b>5</b>	<b>Grounding</b>	Standard grounding			
<b>6</b>	<b>HS Code</b>	8536690000			



Wenzhou Safewire Electric Co.,Ltd.

No.152 Xingguang Road, Xingguang industry zone, Liushi town, Yueqing, Wenzhou,China ,325604

---

Serial No.	Parameter	Description
1	<b>Panel Material</b>	Brass alloy/Stainless steel
2	<b>Surface finish</b>	Wire drawing/Polishing/Spray painting
3	<b>Panel Dimension(mm)</b>	210*140
4	<b>Cutout(mm)</b>	190x120
5	<b>Capacity of modules</b>	6 ways modules
6	<b>Mounting type</b>	Declining angle installation
7	<b>Sink box Material</b>	Steel+Zinc plated
8	<b>Base box dimension(mm)</b>	190*120*75
9	<b>Available modules</b>	45*45/22.5*45 ( mm )

## **Application:**



- Office and education
- Industry and Engineering
- Presentation and retail;
- Orientation and safety;
- Transit areas and parking;
- Hotels, hospitality and wellness;
- Health, sport and leisure;
- Art and culture;

## **Installation instructions:**

1. Remove the panel from the bottom box along with the electrical modules.
2. Fix the flooring with spare screws on the bottom box and



place it in the embedded hole.

3. The flooring surface shall be at least level with the ground or 20mm below the ground.

4. Remove flooring surface ,Insert the 10--12mm lead head into the terminal of floor box.

5. Fix the panel to the bottom box with screws.

### **Attentions:**

1. Dispose of trash in bottom box and prevent dirt and debris from entering inside.

2.The sealing ring is closely attached to the smooth surface to prevent water leakage.

3.Prevent from alkaline corrosion and humidity.

4.When installing, pay attention to the opening direction,the length of the conductor to the bottom box shall not exceed 10cm,Set aside at least 200mm of cable.

5.When installing and wiring,Product should avoid direct contact with corrosive liquid, gas (strong acid, strong alkali, paint).

6. This product is suitable for dry surface treatment, avoid

water flush and immersion, and ensure its insulation

7. Avoid acid alkaline solution flushing, avoid scratch of transparent protective paint, ensure corrosion resistance.

## Package



### **Method of use:**

Gently press the outlet with your hand and lift the lid ,the lid will open along with it to reveal the function keys inside.(Another way is to open the lid directly to expose the functional module).



**SAFEWIRE**

Wenzhou Safewire Electric Co.,Ltd.

No.152 Xingguang Road, Xingguang industry zone, Liushi town, Yueqing, Wenzhou,China ,325604

---

## Product Show:

HTD-302AL

DK cable exit  
Code:DK

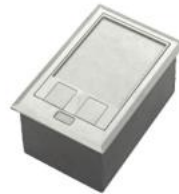

HTD-302AL Alu alloy



Cover middle with 8 mm  
concavity ,  
Concave side can be filled  
with flooring.





## **Features:**

1. **The lid was opened at 90 degrees** : Open the cover with the ground 90 degrees, furthermore , open and ground into a 180 degree flat is also available. When using, open the cover horizontally to the floor to avoid accident potential and product damage caused by cover erection.
2. **Simple installation**: Hinged cover with screw fix to steel box body.
3. **The outlet way of the line can be chosen,DK type cable exit or HK type cable exit** : The outlet port(reverse) can lead multi-strand wire cable out of the floor socket and effectively protect the wire cable skin against damaging. This cord outlet flaps fold down when in use to all cords out with main cover closed.

### **CABLE EXIT** PROTECTIVE PORT

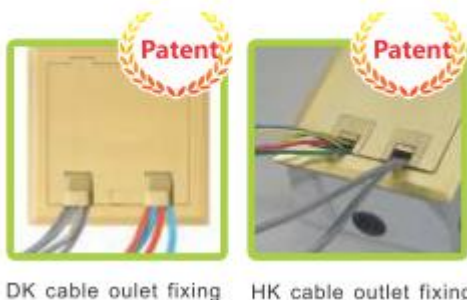

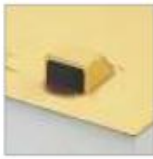

DK cable exit  
Code:DK



HK cable exit  
Code:HK

4. **More Strong Scratch Resistance:** Surface finish made from stainless steel or Brass by combination of tough material, Aluminum (ADC12) and shot blast finish on the surface achieves high scratch resistance.
5.  **durable socket receptacle:**Using elastic phosphor copper avoids playing spark plug and plug set to bit dead ,ensure high conductivity and more life of pulling and plugging over 15000 times.PC+ABS(1.Modules fireproof : 850 degree C temp.; 2.Modules don't distortion under 102 degree C temp.; 3.Stand under 15 degree C temp) ;Oxygen Insulation & Fire resistance in accordance with UL94 international standard.
6. **Good sealing :** With temporary lid-secure to body during pour to prevent ingress of slurry.
7. **Power-coated steel box has 10\*25mm conduit and diameter of 27mm diameter knock-outs available to accommodate CAT 6A cabling available on request.**

# HTD-302AL Outline drawing:



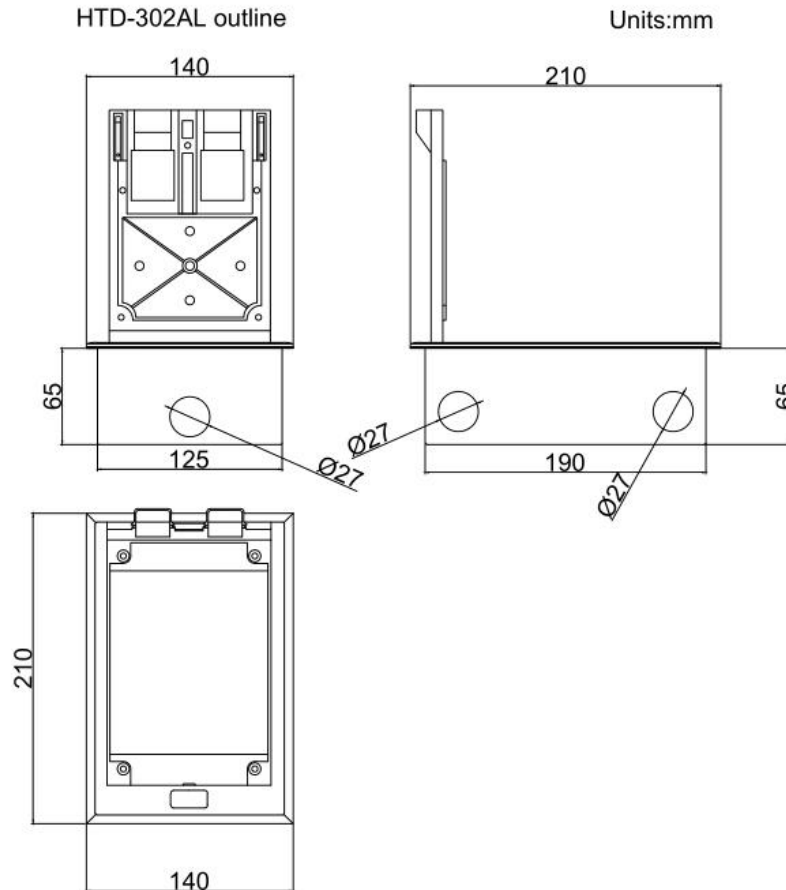

















## SAFEWIRE



Available sockets or modules types:

## SAFEWIRE

45 Type Function Accessories

								
F2	F3	F4	F11	F15	F16	F18		
								
F20/F21/F22/F23/F25/F28	F50	F51	F52	F53	F55	F56	F58	F59
								
F60	F62	F65/F66/F67/F68	F68	F71				