

Wenzhou Safewire Electric CO.,Ltd.

SPECIFICATION SHEET

PRODUCT NAME: Pop up floor socket

PRODUCT No. : HTD-3



HTD-3

ADD: 152 xinguang industrial zone, yueqing city, zhejiang province

(TEL) :0086-577-62799688

(E-mail) : info@safewirele.com

(WEB): <http://www.safewirele.com>



Technical parameters & characteristic :

1) Working environment:

1. The environment temperature:-5°C~/40°C
2. The rated voltage : 100V~~250V
3. Rated current : 10A、 13A、 16A、 20A

2) Characteristic:

1	Model	HTD-3	6	HS Code	8536690000
2	Brand Name	Safewire or OEM brand	7	Market standard	Customized
3	Type	floor socket	8	Place of origin	Zhejiang , Wenzhou, China
4	Color	Golden, silver	9	Frequency	50Hz~60Hz
5	Grounding	Standard grounding	10	Current Type	AC

3) Technical parameters :

Serial No.	Parameter	Description
1	Panel Material	Brass alloy/Alu alloy
2	Surface finish	Wire drawing/Polishing/Spray painting
3	Panel Dimension(mm)	Ø150
4	Cutout(mm)	105x105
5	Capacity of modules	3 ways modules
6	Bracket material	Zinc Alloy & Alu Alloy
7	Sink box Thickness	1.2mm
8	Sink box Material	Steel+Zinc plated
9	Available modules	45*45/45*22.5(mm)
10	Damping device (DP)	Normal Pop-up & Soft Pop-up available
11	N.W(kg)	20.3
12	G.W(kg)	21.6
13	Carton size(cm)	41.5*32.5*32.5



SAFEWIRE

Wenzhou Safewire Electric Co.,Ltd.

No.152 Xingguang Road, Xingguang industry zone, Liushi town, Yueqing, Wenzhou,China ,325604

lication :

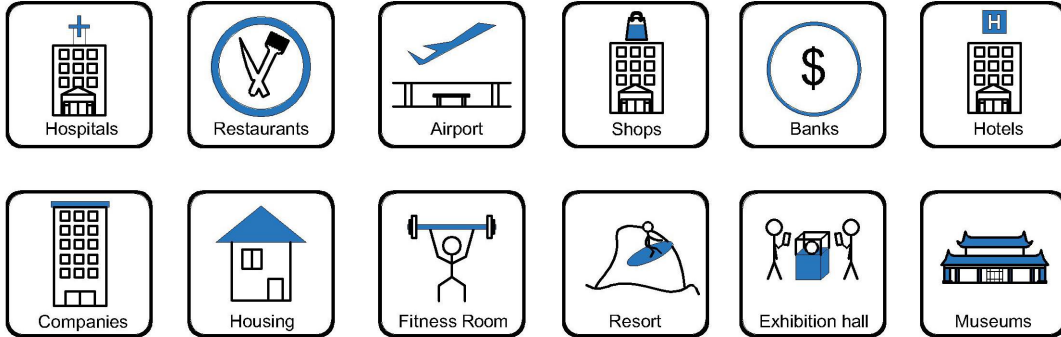

- Office and education
- Industry and Engineering
- Presentation and retail;
- Orientation and safety;
- Transit areas and parking;
- Hotels, hospitality and wellness;
- Health, sport and leisure;
- Art and culture;



CE certificate by TUV,Germany

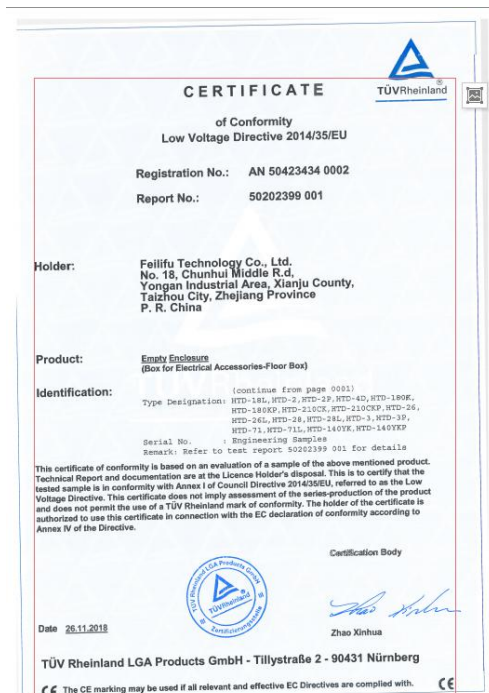

LVD test report

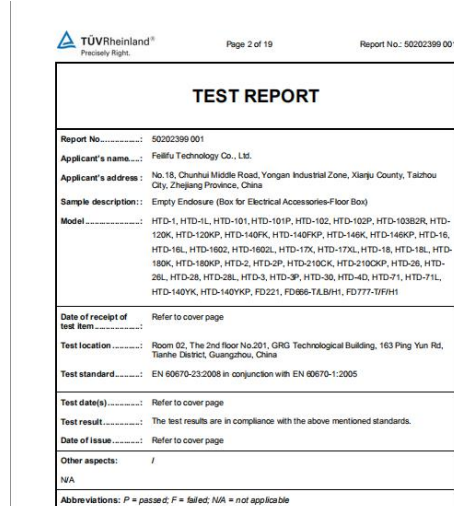

Product Show:



Brass color



Silver color



Bottom box

Features:

1. Easy Die-cut: round shape of Ø120mm.
2. Fast-wiring: more terminal block for 1~2.5m² rigid wire or 0.5~6m² prepared flexible wire.
3. Easy-Installation: Patented technology of clip flush mounting frame of modules replacement. Save labor cost.

1.Easy-Installation

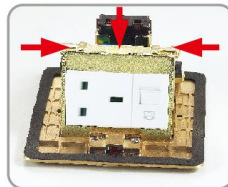
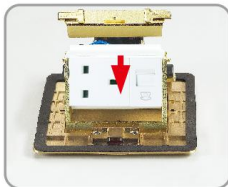

3.Safety Damping Device



Pop-up Slowly



More Safety



Soft Pop-up
Code:ZN

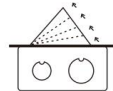

10 times

The opening speed of which is 10 times slower than regular products.

2.Fast-Wiring

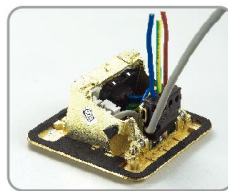
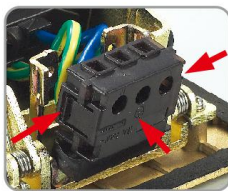

4.Heavy Material Box



Available for F type 45*45mm type or D type22.5*45mm international sockets or modules types:

SAFEWIRE

45 Type Function Accessories

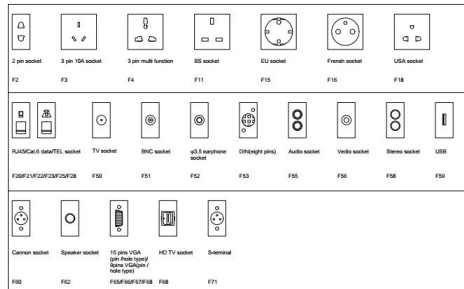

HTD-3 Outline drawing:

SAFEWIRE

HTD-3 outline

Units:mm

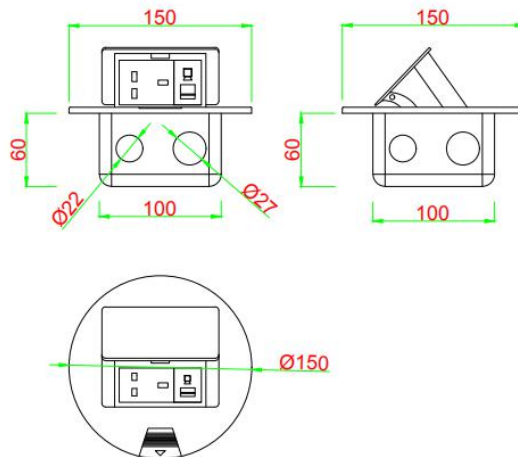

Package:20 Pcs inner box into a master carton.Poly bag with box packing.



SAFEWIRE

Wenzhou Safewire Electric Co.,Ltd.

No.152 Xingguang Road, Xingguang industry zone, Liushi town, Yueqing, Wenzhou,China ,325604



Installation Guide

- 1.Swing out from its floor mounted frame thru a spring attached finger level. Outlet bracket is attached to its pop up cover .
- 2.Remove panel from the bottom box along with the electrical modules.
- 3.Remove lid surface ,Insert the 10--12mm lead head into the terminal of floor box.
- 4.Fix the flooring with spare screws on bottom box and place it in embedded hole.

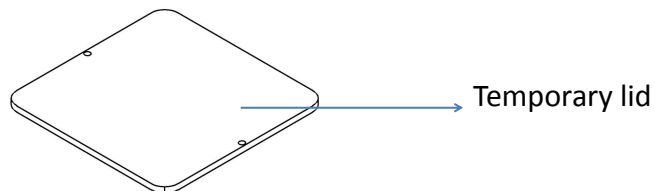
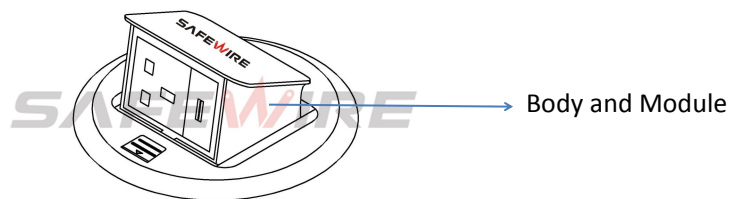

(Image is for reference only.)

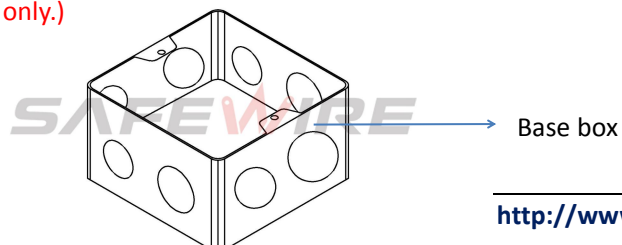



SAFEWIRE

Wenzhou Safewire Electric Co.,Ltd.

No.152 Xingguang Road, Xingguang industry zone, Liushi town, Yueqing, Wenzhou,China ,325604

Attentions:

- 1.Dispose of trash in bottom box and prevent dirt and debris from entering inside.
- 2.Prevent from corrosive liquid, gas (strong acid, strong alkali, paint)and humidity.
- 3.When installing, pay attention to the opening direction,the length of the conductor to the bottom box shall not exceed 10cm,Set aside at least 200mm of cable.
4. All dimension quoted are nominal only. Drawings , images and text are for illustrative perposes only and product details and dimension are subject to change without notice.

Safety Warning:

- 1.This is a class I product and must be earthed
- 2.This product must be installed/wired by a qualified electrician
- 3.For indoor use only.
- 4.For concrete floor.