

Wenzhou Safewire Electric CO.,Ltd.

# SPECIFICATION SHEET

**PRODUCT NAME:** Open coverplate

**PRODUCT No. :** HTD-2702K



HTD-2702K

ADD: 152 xinguang industrial zone, yueqing city, zhejiang province

(TEL) :0086-577-62799688

(E-mail) : info@safewirele.com

(WEB): <http://www.safewirele.com>



Wenzhou Safewire Electric Co.,Ltd.

No.152 Xingguang Road, Xingguang industry zone, Liushi town, Yueqing, Wenzhou,China ,325604

**Technical parameters & characteristic :**

**1) Working environment:**

1. The environment temperature:-5°C~/40°C
2. The rated voltage : 100V~~250V
3. Rated current : 10A、 13A、 16A、 20A

**2) Characteristic:**

|          |                   |                       |           |                        |                           |
|----------|-------------------|-----------------------|-----------|------------------------|---------------------------|
| <b>1</b> | <b>Model</b>      | <b>HTD-2702K</b>      | <b>6</b>  | <b>HS Code</b>         | 8536690000                |
| <b>2</b> | <b>Brand Name</b> | Safewire or OEM brand | <b>7</b>  | <b>Market standard</b> | <b>Customized</b>         |
| <b>3</b> | <b>Type</b>       | floor socket          | <b>8</b>  | <b>Place of origin</b> | Zhejiang , Wenzhou, China |
| <b>4</b> | <b>Color</b>      | Golden, silver, etc   | <b>9</b>  | <b>Frequency</b>       | 50Hz~60Hz                 |
| <b>5</b> | <b>Grounding</b>  | Standard grounding    | <b>10</b> | <b>Current Type</b>    | AC                        |

**3) Technical parameters :**

| Serial No. | Parameter                     | Description                           |
|------------|-------------------------------|---------------------------------------|
| 1          | <b>Panel Material</b>         | Brass alloy/Stainless steel           |
| 2          | <b>Surface finish</b>         | Wire drawing/Polishing/Spray painting |
| 3          | <b>Panel Dimension(mm)</b>    | 270*146                               |
| 4          | <b>Cutout(mm)</b>             | 263x138                               |
| 5          | <b>Capacity of modules</b>    | 12 ways modules                       |
| 6          | <b>Mounting type</b>          | Horizontal installation               |
| 7          | <b>Sink box Material</b>      | Steel+Zinc plated                     |
| 8          | <b>Base box dimension(mm)</b> | 260*135*75                            |
| 9          | <b>Available modules</b>      | 45*45/22.5*45(mm)                     |

## Application:

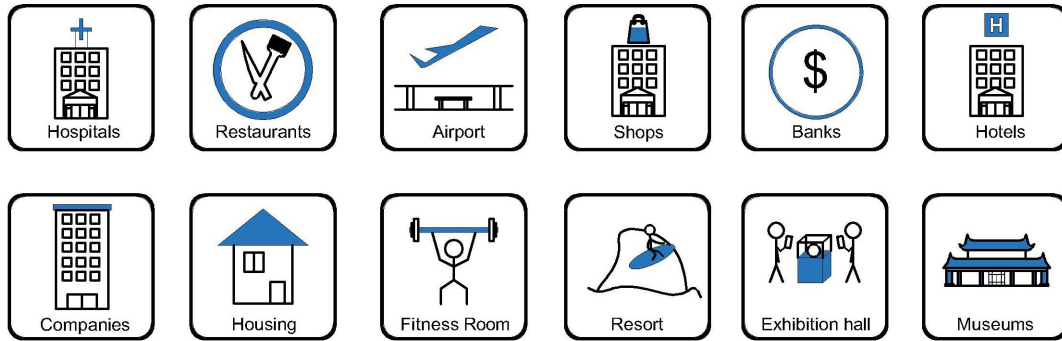

1. This model has bevelled edges to allow the cover to conceal the cut edge of the carpet or floor covering below.
2. The solid stainless/brass steel cover is useful for installation where the flooring material is not suitable for use in a rebated cover .Two cord outlet ports fold into the box to allow cables to exit when in use.
3. Designed to feed workstations or equipment in open plan areas.Cables may be routed to a desk using an optional cable umbilical.
4. For concrete floor/allless floor

## Product Show:



**Features:**

1. **The lid was opened at 90 degrees** : When using, open the cover horizontally of 90 degrees to the floor to avoid accident potential and product damage caused by cover erection.
2. Side-mounting: Outlet bracket for side-mounting for 86 type switch board
3. **The outlet way of the line can be chosen,DK type cable exit or HK type cable exit** :

**CABLE EXIT PROTECTIVE PORT**

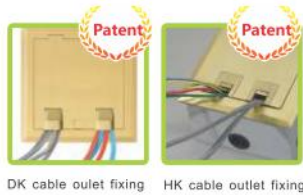





















DK:Single direction outlet.HK:Dual direction outlet.

4. **More Strong Scratch Resistance**: Material made from high quality H62 Brass and stainless 304, Automatic polish robot and painting machine to ensure reliable quality.
5. **Good sealing** : With temporary lid-secure to body during pour to prevent ingress of slurry.
6. **Power-coated steel box has 10\*25mm conduit and diameter of 27mm diameter knock-outs available to accommodate CAT 6A cabling available on request.**

Available for F type 45\*45mm type or D type23\*26mm international sockets or modules types:

**SAFEWIRE**

45 Type Function Accessories

|   |   |   |   |   |   |   |   |  |
|---|---|---|---|---|---|---|---|--|
|  |  |  |  |  |  |  |   |  |
| F2  | F3  | F4  | F11   | F15   | F16   | F18   |   |  |
|  |  |  |  |  |  |  |  |  |
| F20/F21/F22/F23/F25/F28   | F50   | F51   | F52   | F53   | F55   | F56   | F58   | F59  |
|  |  |  |  |  |   |   |   |  |
| F60   | F62   | F65/F66/F67/F68   | F68   | F71   |   |   |   |  |



**SAFEWIRE**

Wenzhou Safewire Electric Co.,Ltd.

No.152 Xingguang Road, Xingguang industry zone, Liushi town, Yueqing, Wenzhou,China ,325604

**HTD-2702K Outline drawing:**

**SAFEWIRE**

HTD-2702K outline

Units:mm

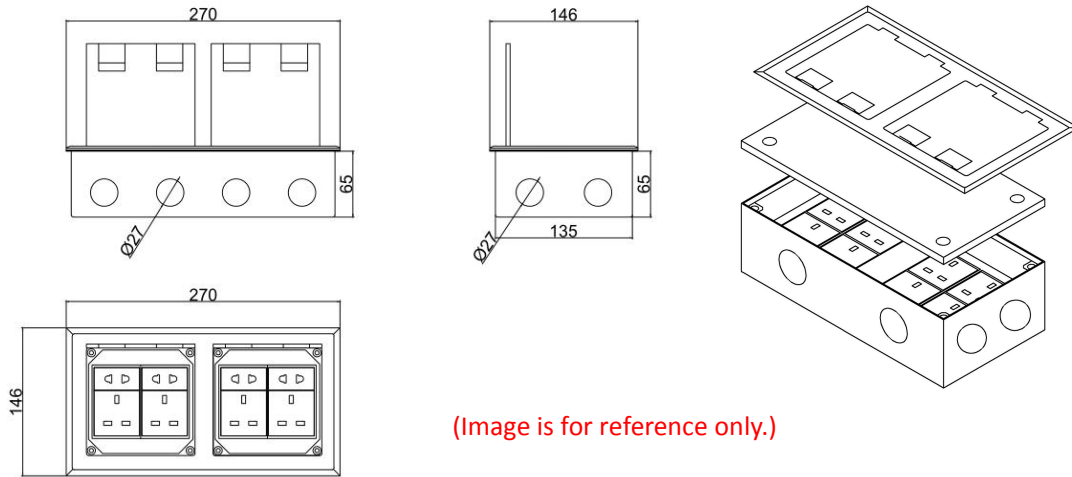

(Image is for reference only.)

**Package:**4 Pcs inner box into a master carton.Poly bag with box packing.

**SafeWire**

Package solution

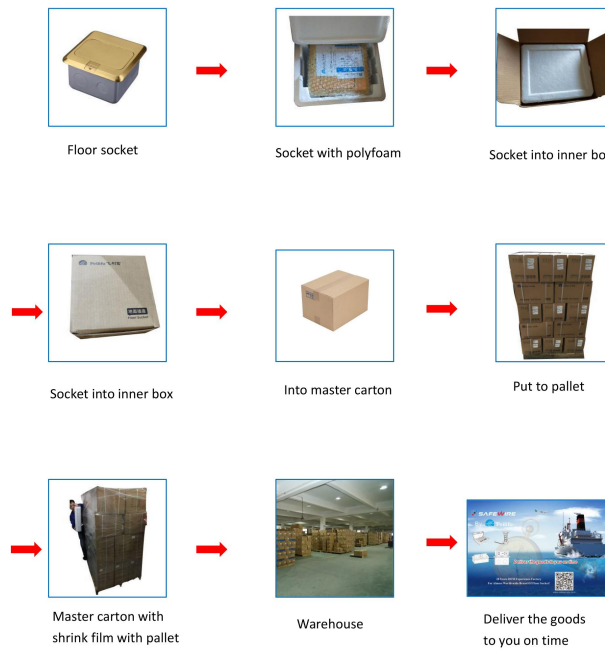

[www.safewirele.com](http://www.safewirele.com)

**Installation instructions:**

1. Cut out 198\*198(mm), Powering the slurry.
2. Remove the pre-installed temporary lid,wiring and installing modules.
3. Per-installthe cable pipe as per your request .
4. Install cover lid and tighten with screws.
5. Conceal the cut edge of carpet of flooring

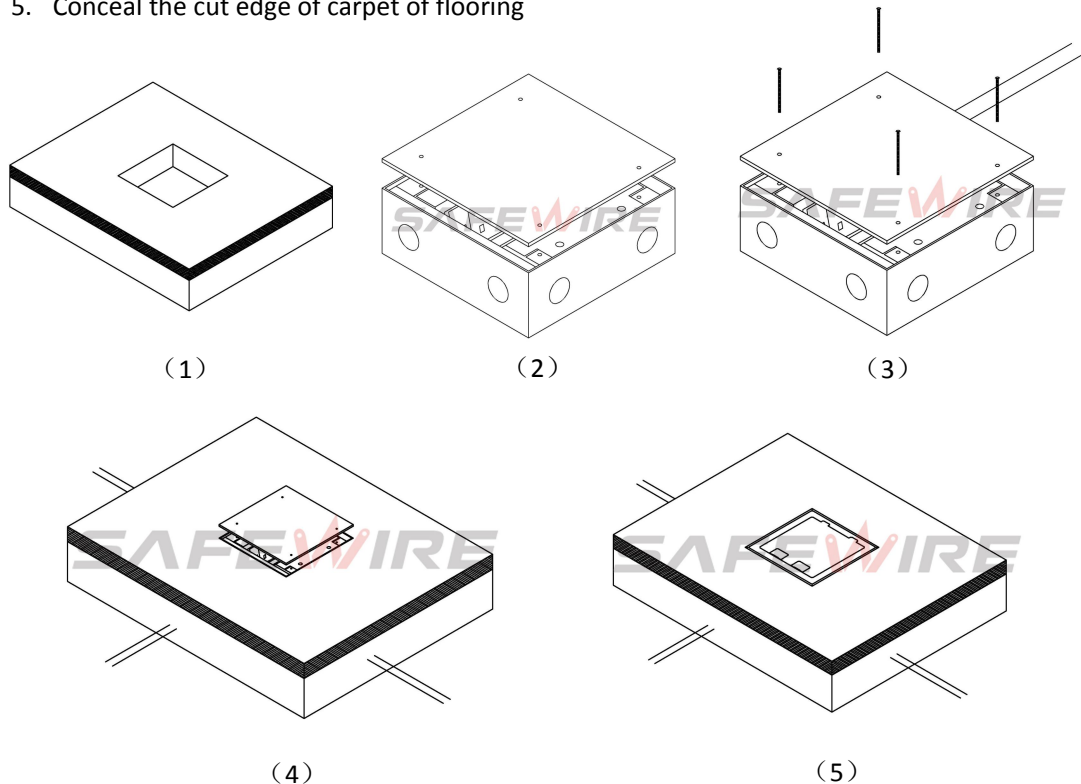

**Attentions:**

- 1.When installing and wiring,Product should avoid direct contact with corrosive liquid, gas (strong acid, strong alkali, paint).
- 2.This product is suitable for dry surface treatment, avoid water flush and immersion, and ensure its insulation.This product is not suitable for use in wet areas.
- 3.All dimensions quotes are nominal only.Drawing images and specification are only for illustrative purposes and dimensions are subject to final confirmation by us.

**Safety Warning:**

- 1.This is a class I product and must be earthed
- 2.This product must be installed/wired by a qualified electrician
- 3.For indoor use only.
- 4.For concrete access floor.