

Wenzhou Safewire Electric CO.,Ltd.

SPECIFICATION SHEET

PRODUCT NAME: Open coverplate

PRODUCT No. : HTD-251CK



HTD-251CK

ADD: 152 xinguang industrial zone, yueqing city, zhejiang province

(TEL) :0086-577-62799688

(E-mail) : info@safewirele.com

(WEB): <http://www.safewirele.com>



Technical parameters & characteristic :

1) Working environment:

1. The environment temperature:-5°C~/40°C
2. The rated voltage : 100V~~250V
3. Rated current : 10A、 13A、 16A、 20A

2) Characteristic:

1	Model	HTD-251CK	6	HS Code	8536690000
2	Brand Name	Safewire or OEM brand	7	Market standard	Customized
3	Type	floor socket	8	Place of origin	Zhejiang , Wenzhou, China
4	Color	Golden, silver, etc	9	Frequency	50Hz~60Hz
5	Grounding	Standard grounding	10	Current Type	AC

3) Technical parameters :

Serial No.	Parameter	Description
1	Panel Material	Brass alloy/Stainless steel
2	Surface finish	Wire drawing/Polishing/Spray painting
3	Panel Dimension(mm)	250*180
4	Cutout(mm)	243*173
5	Capacity of modules	12 ways modules
6	Mounting type	Horizontal installation
7	Bracket material	Zinc Alloy & Alu Alloy
8	Sink box Material	Steel+Zinc plated
9	Base box dimension(mm)	240*170*75
10	Available modules	45*45/22.5*45(mm)

Application:

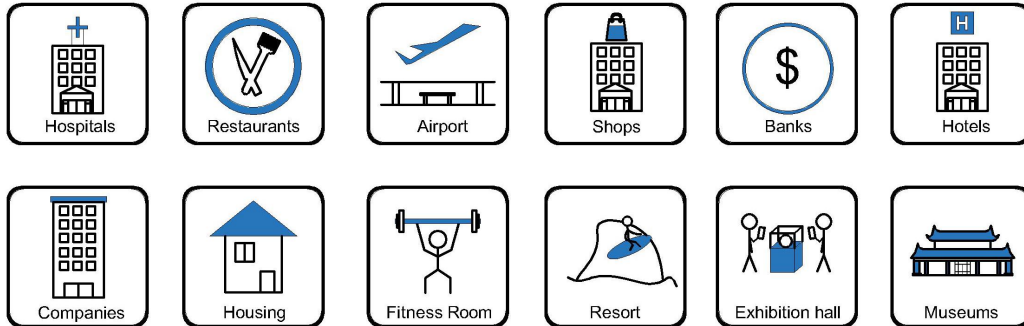

1. This model has bevelled edges to allow the cover to conceal the cut edge of the carpet or floor covering below.

2. The solid stainless/brass steel cover is useful for installation where the flooring material is not suitable for use in a rebated cover .Two cord outlet outlet ports fold into the box to allow cables to exit when in use.

3. Designed to feed workstations or equipment in open plan areas.Cables may be routed to a desk using an optional cable umbilical.

4. For concrete floor/alless floor

Product Show





SAFEWIRE

Wenzhou Safewire Electric Co.,Ltd.

No.152 Xingguang Road, Xingguang industry zone, Liushi town, Yueqing, Wenzhou,China ,325604

Features:

1. Application: Recessed stage floor box provides versatile solution to accessing power, audio and visual equipment through floor .
2. More plug top clearance:side-mounting installation of frame/ modules.
3. Hinged lid thickness over 4~4.5m , static pressure over 1000N .
4. Cold-rolled Steel box thickness over 1.5~2.0mm with powder coated.

Cable Exit
Protective
Port



DK cable outlet fixing



HK cable outlet fixing

DK DK Cable Exit
Code:DK























HK HK Cable Exit
Code:HK



Available for F type 45*45mm type or D type22.5*45mm international sockets or modules types:

SAFEWIRE

45 Type Function Accessories

								
2 pin socket	3 pin 10A socket	3 pin multi function	BS socket	EU socket	French socket	USA socket		
F2	F3	F4	F11	F15	F16	F18		
								
RJ45/Cat.6 data/TEL socket	TV socket	BNC socket	3.5 earphone socket	DIN(eight pins)	Audio socket	Video socket	Stereo socket	USB
F20/F21/F22/F23/F25/F28	F50	F51	F52	F53	F55	F56	F58	F59
								
Cannon socket	Speaker socket	15 pins VGA (pin hole type) / Spins VGA (pin / hole type)	HD TV socket	S-terminal				
F60	F62	F65/F66/F67/F68	F68	F71				

HTD-251CK Outline drawing:

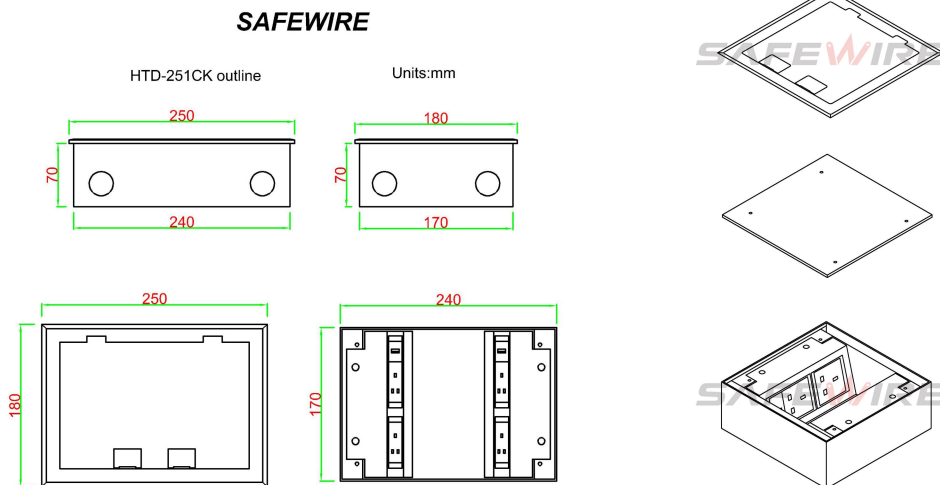

(Image is for reference only.)

Package:4 Pcs inner box into a master carton.Poly bag with box packing.

SafeWire

Package solution



www.safewirele.com

Installation instructions:

1. Cut out 243*173(mm), Powering the slurry.
2. Remove the pre-installed temporary lid,wiring and installing modules.
3. Per-installthe cable pipe as per your request .
4. Install cover lid and tighten with screws.
5. Conceal the cut edge of carpet of flooring

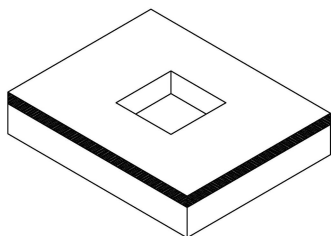

(1)

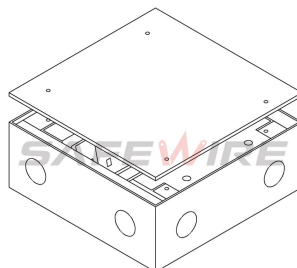

(2)

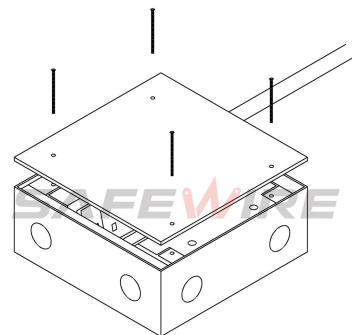

(3)



SAFEWIRE

Wenzhou Safewire Electric Co.,Ltd.

No.152 Xingguang Road, Xingguang industry zone, Liushi town, Yueqing, Wenzhou,China ,325604

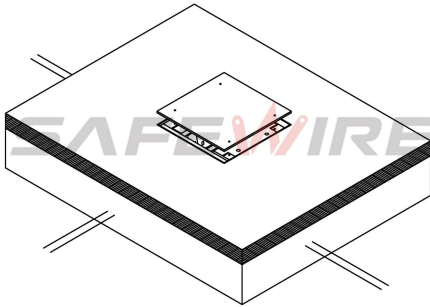

(4)

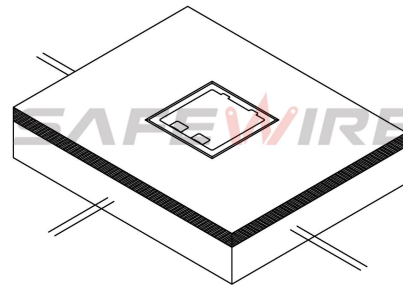

(5)

Attentions:

- 1.When installing and wiring,Product should avoid direct contact with corrosive liquid, gas (strong acid, strong alkali, paint).
- 2.This product is suitable for dry surface treatment, avoid water flush and immersion, and ensure its insulation.This product is not suitable for use in wet areas.
- 3.All dimensions quotes are nominal only.Drawing images and specification are only for illustrative purposes and dimensions are subject to final confirmation by us.

Safety Warning:

- 1.This is a class I product and must be earthed
- 2.This product must be installed/wired by a qualified electrician
- 3.For indoor use only.
- 4.For concrete access floor.