

Wenzhou Safewire Electric CO.,Ltd.

SPECIFICATION SHEET

PRODUCT NAME: Pop up floor socket/Service power

PRODUCT No. : HTD-16



ADD: 152 xinguang industrial zone, yueqing city, zhejiang province,China

(TEL) :0086-577-62799688

(E-mail) : info@safewirele.com

(WEB): <http://www.safewirele.com>



Technical parameters & characteristic :

1) Working environment:

1. The environment temperature:-5°C~/40°C
2. The rated voltage : 100V~~250V
3. Rated current : 10A、 13A、 16A、 20A

2) Characteristic:

1	Model	HTD-16	6	HS Code	8536690000
2	Brand Name	Safewire or OEM brand	7	Market standard	Customized
3	Type	floor socket	8	Place of origin	Zhejiang , Wenzhou, China
4	Color	Golden, silver	9	Frequency	50Hz~60Hz
5	Grounding	Standard grounding	10	Current Type	AC

3) Technical parameters :

Serial No.	Parameter	Description
1	Panel Material	Brass alloy/Alu alloy
2	Surface finish	Wire drawing/Polishing/Spray painting
3	Panel Dimension(mm)	120*120
4	Cutout(mm)	100x100
5	Capacity of modules	3 ways modules
6	Bracket material	Zinc Alloy & Alu Alloy
7	Sink box Thickness	1.2mm
8	Sink box Material	Steel+Zinc plated
9	Available modules	45*45/45*22.5(mm)
10	Damping device (DP)	Normal Pop-up & Soft Pop-up available
11	N.W(kg)	1.00 (Brass alloy);0.76(Alu alloy)
12	G.W(kg)	20.8(Brass alloy);15.8(Alu alloy)
13	Carton size(cm)	41.5x27x27

Application:

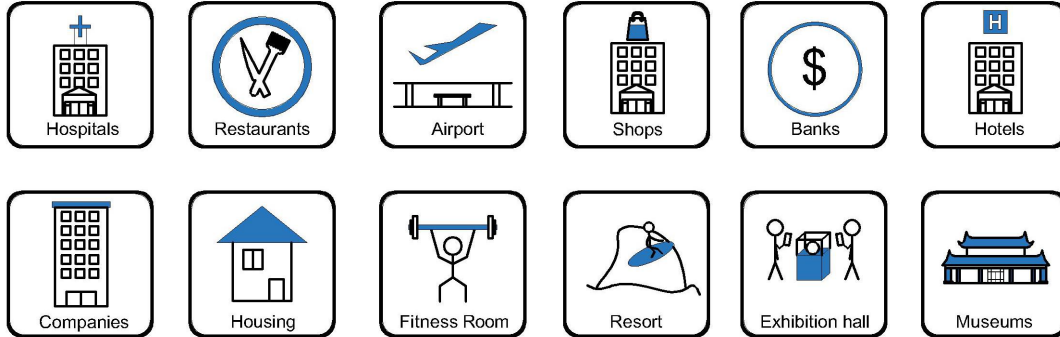

- Office and education
- Industry and Engineering
- Presentation and retail;
- Orientation and safety;
- Transit areas and parking;
- Hotels, hospitality and wellness;
- Health, sport and leisure;
- Art and culture;



CE certificate by TUV,Germany

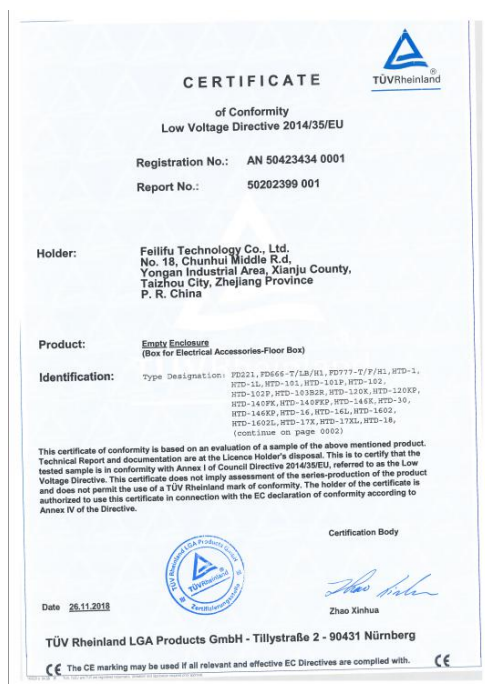

LVD test report

TÜVRheinland® Precisely Right.		Page 2 of 19	Report No.: 50202399 001
TEST REPORT			
Report No.:	50202399 001		
Applicant's name:	Fellifu Technology Co., Ltd.		
Applicant's address:	No. 18, Chunhui Middle Road, Yongnan Industrial Zone, Xianju County, Taizhou City, Zhejiang Province, China		
Sample description:	Empty Enclosure (Box for Electrical Accessories-Floor Box)		
Model:	HTD-1, HTD-4L, HTD-101, HTD-101P, HTD-102, HTD-102P, HTD-103B2R, HTD-120K, HTD-120KP, HTD-140FK, HTD-140FKP, HTD-146K, HTD-146KP, HTD-16, HTD-16L, HTD-1602, HTD-1602L, HTD-17X, HTD-17XL, HTD-18, HTD-18L, HTD-180K, HTD-180KP, HTD-2, HTD-2P, HTD-210CK, HTD-210CKP, HTD-26, HTD-26L, HTD-28, HTD-28L, HTD-3, HTD-3P, HTD-30, HTD-40, HTD-71, HTD-71L, HTD-140YK, HTD-140YKP, FD221, FD966-TLBAH1, FD777-TWFH1		
Date of receipt of test item:	Refer to cover page		
Test location:	Room 02, The 2nd floor No.201, GRG Technological Building, 163 Ping Yun Rd, Tianhe District, Guangzhou, China		
Test standard:	EN 60670-23:2008 in conjunction with EN 60670-1:2005		
Test date(s):	Refer to cover page		
Test result:	The test results are in compliance with the above mentioned standards.		
Date of issue:	Refer to cover page		
Other aspects:	/		
N/A			
Abbreviations: P = passed; F = failed; N/A = not applicable			

Product Show:



Features:

1.Easy to install: Fast connect wire for terminal block as fast wiring connection.

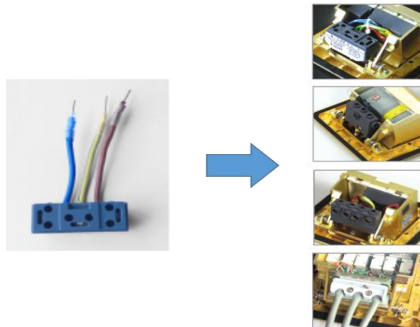

2. More Strong Scratch Resistance: Surface finish made from Brass by combination of tough material, Aluminum (ADC12) .

3.durable socket receptacle:Using elastic phosphor copper , high conductivity ,pulling and plugging over 15000 times.PC+ABS fireproof : 850 degree C temp.; Oxygen Insulation & Fire resistance in accordance with UL94 standard.

4. Long lifetime of push button: ,more than 5000 times of push button.

5.More soft and slow damping device:The damping speed of our device is 10 times slower than simliar products.Our damping have been patented



Soft Pop-up
Code:ZN



Pop-up Slowly



More safety

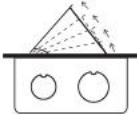

10 Times

The floor socket equipped with soft starting device, the opening speed of which is 20 times slower than regular products.
State for opening: uniform speed, slow.

7.More heavy duty of bottom boxes:Thickness of bottom boxes body is over 1mm.
Available for F type 45*45mm type or D type23*26mm international sockets or modules types:

SAFEWIRE

45 Type Function Accessories

F2	F3	F4	F11	F15	F16	F18
F20	F21	F22	F23	F24	F25	F26
F27	F28	F29	F30	F31		



SAFEWIRE

Wenzhou Safewire Electric Co.,Ltd.

No.152 Xingguang Road, Xingguang industry zone, Liushi town, Yueqing, Wenzhou,China ,325604

HTD-16 Outline drawing:

SAFEWIRE

HTD-16 outline

Units: mm

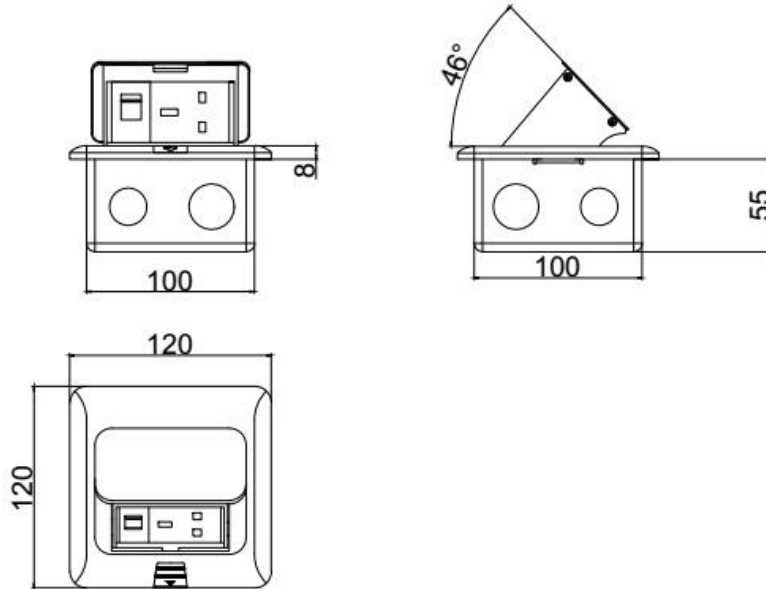

Package:20 Pcs inner box into a master carton.Poly bag with box packing.



Installation Guide (The exact products should be subject to confirmation by seller)

Hold the lid down with your hand,Pull the push button as the direction, Panel popup.

- 1.Remove panel from the bottom box along with the electrical modules.
- 2.Fix the flooring with spare screws on bottom box and place it in embedded hole.
- 3.The flooring surface shall be at least level with the ground or 20mm below the ground.
- 4.Remove lid surface ,Insert the 10--12mm lead head into the terminal of floor box.
- 5.Fix the panel to the bottom box with screws.

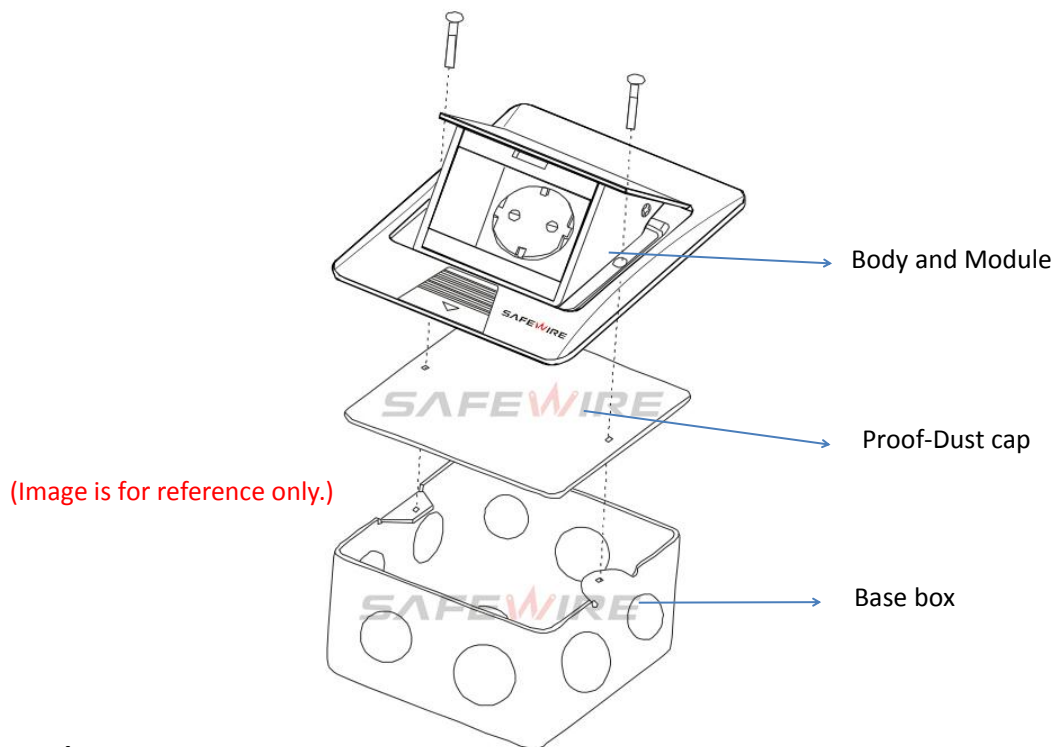

Attentions:

- 1.Dispose of trash in bottom box and prevent dirt and debris from entering inside.
- 2.The sealing ring is closely attached to the smooth surface to prevent water leakage.
- 3.Prevent from alkaline corrosion and humidity.
- 4.When installing, pay attention to the opening direction,the length of the conductor to the bottom box shall not exceed 10cm,Set aside at least 200mm of cable.
- 5.When installing and wiring,Product should avoid direct contact with corrosive liquid, gas (strong acid, strong alkali, paint).

Safety Warning:

- 1.This is a class I product and must be earthed
- 2.This product must be installed/wired by a qualified electrician
- 3.For indoor use only.
- 4.For concrete floor.