

Wenzhou Safewire Electric CO.,Ltd.

# SPECIFICATION SHEET

**PRODUCT NAME :** Open coverplate

**PRODUCT No. :** HTD-130



HTD-130LX

ADD: 152 xinguang industrial zone, yueqing city, zhejiang province

(TEL) :0086-577-62799688

(E-mail) : info@safewirele.com

(WEB): <http://www.safewirele.com>



**Technical parameters & characteristic :**

**1) Working environment:**

1. The environment temperature:-5°C~/40°C
2. The rated voltage : 100V~~250V
3. Rated current : 10A、 13A、 16A、 20A

**2) Characteristic:**

|          |                   |                       |           |                        |                           |
|----------|-------------------|-----------------------|-----------|------------------------|---------------------------|
| <b>1</b> | <b>Model</b>      | <b>HTD-130</b>        | <b>6</b>  | <b>HS Code</b>         | 8536690000                |
| <b>2</b> | <b>Brand Name</b> | Safewire or OEM brand | <b>7</b>  | <b>Market standard</b> | <b>Customized</b>         |
| <b>3</b> | <b>Type</b>       | floor socket          | <b>8</b>  | <b>Place of origin</b> | Zhejiang , Wenzhou, China |
| <b>4</b> | <b>Color</b>      | Golden, silver, etc   | <b>9</b>  | <b>Frequency</b>       | 50Hz~60Hz                 |
| <b>5</b> | <b>Grounding</b>  | Standard grounding    | <b>10</b> | <b>Current Type</b>    | AC                        |

**3) Technical parameters :**

| Serial No. | Parameter                     | Description                           |
|------------|-------------------------------|---------------------------------------|
| 1          | <b>Panel Material</b>         | Brass alloy/Stainless steel           |
| 2          | <b>Surface finish</b>         | Wire drawing/Polishing/Spray painting |
| 3          | <b>Panel Dimension(mm)</b>    | φ130                                  |
| 4          | <b>Cutout(mm)</b>             | 122*122                               |
| 5          | <b>Capacity of modules</b>    | 2 ways modules                        |
| 6          | <b>Horizontal mounting</b>    | Horizontal installation               |
| 7          | <b>Sink box Material</b>      | Steel+Zinc plated                     |
| 8          | <b>Base box dimension(mm)</b> | 120*120*60                            |
| 9          | <b>Available modules</b>      | 45*45/22.5*45(mm)                     |



**Application:**

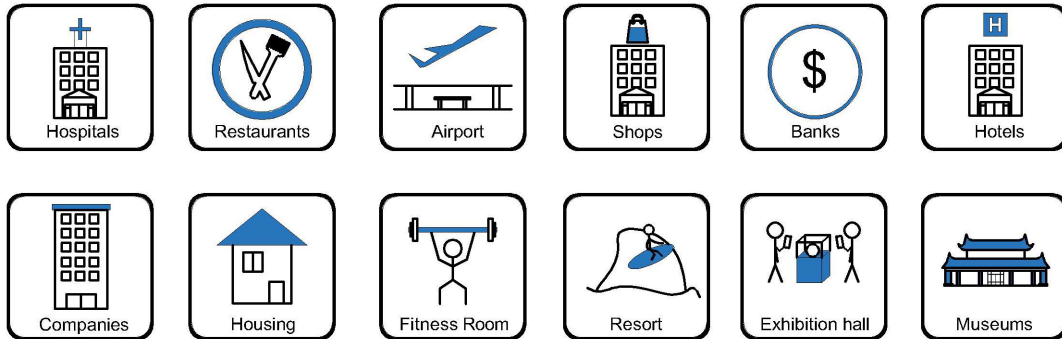

- Office and education
- Industry and Engineering
- Presentation and retail;
- Orientation and safety;
- Transit areas and parking;
- Hotels, hospitality and wellness;
- Health, sport and leisure;
- Art and culture;
- 

**Installation instructions:**

1. Remove the panel from the bottom box along with the electrical modules.
2. Fix the flooring with spare screws on the bottom box and place it in the embedded hole.
3. The flooring surface shall be at least level with the ground or 20mm below the ground.
4. Remove flooring surface ,Insert the 10--12mm lead head into the terminal of floor box.
5. Fix the panel to the bottom box with screws.

**Attentions:**

1. Dispose of trash in bottom box and prevent dirt and debris from entering inside.
- 2.The sealing ring is closely attached to the smooth surface to prevent water leakage.
- 3.Prevent from alkaline corrosion and humidity.
- 4.When installing, pay attention to the opening direction,the length of the conductor to the bottom box shall not exceed 10cm,Set aside at least 200mm of cable.
- 5.When installing and wiring,Product should avoid direct contact with corrosive liquid, gas (strong acid, strong alkali, paint).
6. This product is suitable for dry surface treatment, avoid water flush and immersion, and ensure its insulation
7. Avoid acid alkaline solution flushing,avoid scratch of transparent protective paint,ensure corrosion resistance.



**SAFEWIRE**

Wenzhou Safewire Electric Co.,Ltd.

No.152 Xingguang Road, Xingguang industry zone, Liushi town, Yueqing, Wenzhou,China ,325604

---



**Package:**8 Pcs inner box into a master carton.Poly bag with box packing.

**Product Show:**





**Features:**

- 1. 4-direction junction boxes :configured with up to four opening sides in combinations to provide for a wide variety of duct applications.
- 2. Junction boxes have adjustable cover plate assemblies which allow for adjustment upwards permitting accurate leveling to the finished floor.
- 3. A series of stainless or brass pans and rings are available to accept a wide range of floor finishes.



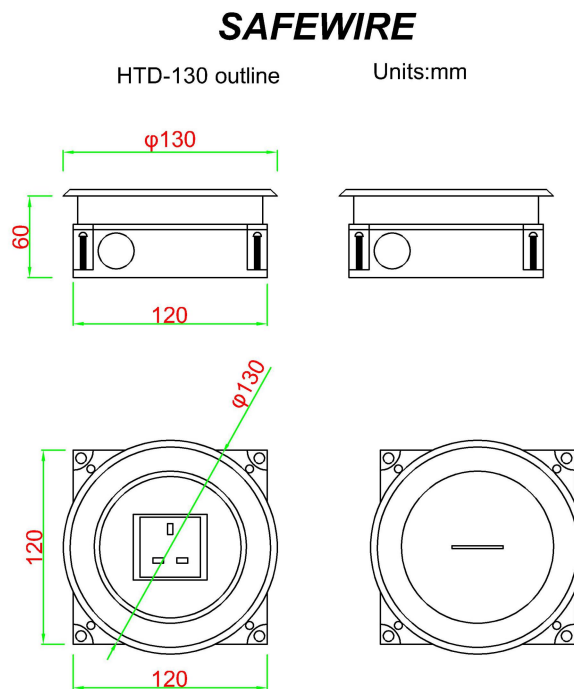

















**HTD-130 Outline drawing:**



Available sockets or modules types:

## SAFEWIRE

### 45 Type Function Accessories

|   |   |   |   |   |  |   |   |   |
|---|---|---|---|---|--|---|---|---|
|  |  |  |  |  |  |  |   |   |
| 2 pin socket  | 3 pin 10A socket  | 3 pin multi function  | BS socket   | EU socket   | French socket  | USA socket  |   |   |
| F2  | F3  | F4  | F11   | F15   | F16  | F18   |   |   |
|  |  |  |  |  |   |    |  |  |
| RJ45Cat.6 data/TEL socket   | TV socket   | BNC socket  | q3.5 earphone socket  | DIN(eight pins)   | Audio socket   | Video socket  | Stere socket  | USB   |
| F20F21/F22F23F25F28   | F50   | F51   | F52   | F53   | F55  | F56   | F58   | F59   |
|  |  |  |  |  |  |   |   |   |
| Cannon socket   | Speaker socket  | 15 pins VGA (pin hole type) / Spine VGA (pin / hole type)                         | HD TV socket  | S-terminal  |  |   |   |   |
| F60   | F62   | F65F66F67F68  | F68   | F71   |  |   |   |   |