



Wenzhou Safewire Electric Co.,Ltd.  
No.152 Xingguang Road, Xingguang industry zone, Liushi town, Yueqing, Wenzhou,China ,325604  
Tel:0086-577-62799688; Email:info@safewirele.com;  
[www.safewirele.com](http://www.safewirele.com)

---

Wenzhou Safewire Electric CO.,Ltd.

## SPECIFICATION SHEET

**PRODUCT NAME:**            Desktop socket  
**PRODUCT No. :**            FZ-528

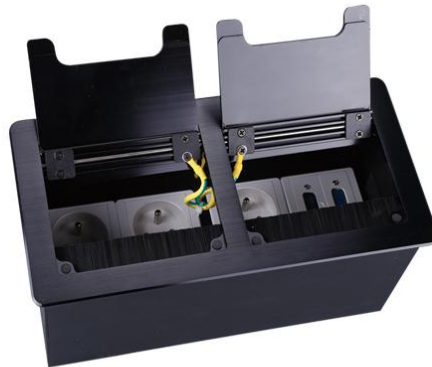

FZ-528

ADD: 152 xingguang industrial zone, yueqing city, zhejiang province  
(TEL) :0086-577-62799688  
(E-mail): info@safewirele.com  
(WEB): <http://www.safewirele.com>



**Wenzhou Safewire Electric Co.,Ltd.**

No.152 Xingguang Road, Xingguang industry zone, Liushi town, Yueqing, Wenzhou,China ,325604  
Tel:0086-577-62799688; Email:info@safewirele.com;

[www.safewirele.com](http://www.safewirele.com)

**Technical parameters & characteristic :**

**1) Working environment:**

1. The environment temperature:-5°C~/40°C
2. The rated voltage : 100V~~250V
3. Rated current : 10A、 13A、 16A、 20A

**2) Characteristic:**

<b>1</b>	<b>Model</b>	<b>HTD-521</b>	<b>6</b>	<b>HS Code</b>	8536690000
<b>2</b>	<b>Brand Name</b>	Safewire or OEM brand	<b>7</b>	<b>Market standard</b>	<b>Customized</b>
<b>3</b>	<b>Type</b>	floor socket	<b>8</b>	<b>Place of origin</b>	Zhejiang , Wenzhou, China
<b>4</b>	<b>Color</b>	Black, silver	<b>9</b>	<b>Frequency</b>	50Hz~60Hz
<b>5</b>	<b>Grounding</b>	Standard grounding	<b>10</b>	<b>Current Type</b>	AC

**3) Technical parameters :**

Serial No.	Parameter	Description
1	Panel Material	Aluminum alloy
2	Surface finish	Electroplated/Painted/Power sprayed
3	Panel Dimension(mm)	265*130
4	Cutout(mm)	254*116
5	Height of product(mm)	120
6	Bottom box size(mm)	252*114
7	Bottom box material	ABS Plastic
8	Capacity of modules /Interface size	8 ways 45*45mm modules
9	Configuration	Power outlet+Data outlet or USB charging : Customized as required
10	Cable length	1.5m, 2m,2m or required length

**Application :**

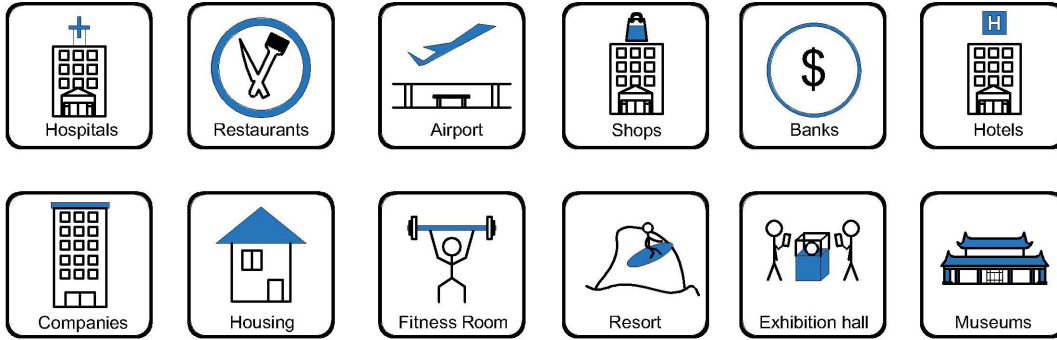

- Office and education
- Industry and Engineering
- Presentation and retail;
- Orientation and safety;
- Transit areas and parking;
- Hotels, hospitality and wellness;
- Health, sport and leisure;
- Art and culture;

**CE certificate by TUV,Germany**



**CERTIFICATE**  
of Conformity  
Low Voltage Directive 2014/35/EU

Registration No.: AN 50423468 0001  
 Report No.: 50202406 001

**Holder:** Feilifu Technology Co., Ltd.  
 No. 18, Chunhui Middle R.d,  
 Yonggan Industrial Area, Xianju County,  
 Taizhou City, Zhejiang Province  
 P. R. China

**Product:** Empty Enclosure  
 (Box for Electrical Accessories-Desktop)

**Identification:** Type Designation: FZ501-D, FZ501-N, FZ510-D, FZ510-N, FZ525-N,  
 FZ515-DZ, FZ515-NZ, FZ517-DZ, FZ517-NZ,  
 FZ518-DZ, FZ518-NZ, FZ507-D, FZ507-N,  
 FZ528-D, FZ528-N, FZ521-D, FZ521-N, FZ536-D,  
 FZ531A-D, FZ531B-D, FZ532A-D, FZ532B-D  
 Serial No. : Engineering Samples  
 Remark: Refer to test report 50202406 001 for details

This certificate of conformity is based on an evaluation of a sample of the above mentioned product. Technical Report and documentation are at the Licence Holder's disposal. This is to certify that the tested sample is in conformity with Annex I of Council Directive 2014/35/EU, referred to as the Low Voltage Directive. This certificate does not imply assessment of the series-production of the product and does not permit the use of a TÜV Rheinland mark of conformity. The holder of the certificate is authorized to use this certificate in connection with the EC declaration of conformity according to Annex IV of the Directive.

Certification Body

  
 Zhao Xinhua

Date 26.11.2018

TÜV Rheinland LGA Products GmbH - Tillystraße 2 - 90431 Nürnberg

CE The CE marking may be used if all relevant and effective EC Directives are complied with. CE

**LVD test report**



Page 2 of 21      Report No.: 50202406 001

**TEST REPORT**

<b>Report No.:</b>	50202406 001
<b>Applicant's name:</b>	Feilifu Technology Co., Ltd.
<b>Applicant's address:</b>	No.18, Chunhui Middle Road, Yonggan Industrial Zone, Xianju County, Taizhou City, Zhejiang Province, China
<b>Sample description:</b>	Empty Enclosure (Box for Electrical Accessories-Desktop)
<b>Model:</b>	FZ501-D, FZ501-N, FZ507-D, FZ507-N, FZ510-D, FZ510-N, FZ515-DZ, FZ515-NZ, FZ517-DZ, FZ517-NZ, FZ518-DZ, FZ518-NZ, FZ528-D, FZ528-N, FZ521-D, FZ521-N, FZ525-N, FZ531A-D, FZ531B-D, FZ532A-D, FZ532B-D, FZ536-S
<b>Date of receipt of test item:</b>	Refer to cover page
<b>Test location:</b>	Room 02, The 2nd floor No.201, GRG Technological Building, 163 Ping Yun Rd, Tianhu District, Guangzhou, China
<b>Test standard:</b>	EN 60670-1:2005+A1:2013
<b>Test date(s):</b>	Refer to cover page
<b>Test result:</b>	The test results are in compliance with the above mentioned standards.
<b>Date of issue:</b>	Refer to cover page
<b>Other aspects:</b>	/
<b>N/A</b>	
<b>Abbreviations:</b>	P = passed; F = failed; N/A = not applicable

**Product Show:**























**Features:**

- 1) This hidden structure provides the user with a compact, clean and convenient connectivity solution;
- 2) Made from die-casting aluminum alloy and painted ;
- 3) Manually open with slower flap up from single side;
- 4) With brush to protect cables from scratch;
- 5) Applicable for wide international 45\*45mm modules including power and intelnet data accessories to meet requirement.

Available sockets or modules types:

**SAFEWIRE**

45 Type Function Accessories

								
2 pin socket	3 pin 10A socket	3 pin multi function	BS socket	EU socket	French socket	USA socket		
F2	F3	F4	F11	F15	F16	F18		
								
RJ45Cat.6 data/TEL socket	TV socket	BNC socket	ø3.5 earphone socket	DIN(eight pins)	Audio socket	Video socket	Stereo socket	USB
F20/F21/F22/F23/F25/F28	F50	F51	F52	F53	F55	F56	F58	F59
								
Cannon socket	Speaker socket	15 pins VGA (pin .hole type) / (pin .VGA) (pin / hole type)	HD TV socket	S-teriminal				
F60	F62	F65/F66/F67/F68	F68	F71				



## Wenzhou Safewire Electric Co.,Ltd.

No.152 Xingguang Road, Xingguang industry zone, Liushi town, Yueqing, Wenzhou,China ,325604  
Tel:0086-577-62799688; Email:info@safewirele.com;

[www.safewirele.com](http://www.safewirele.com)

### FZ-528 Outline drawing:

### SAFEWIRE

FZ-528 outline

Units:mm

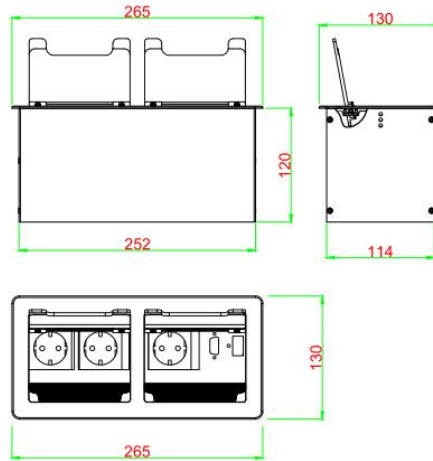

**Package:**2Pcs inner box into a master carton.Poly bag with box packing.

### SafeWire

#### Package solution



[www.safewirele.com](http://www.safewirele.com)

**Installation Guide :**

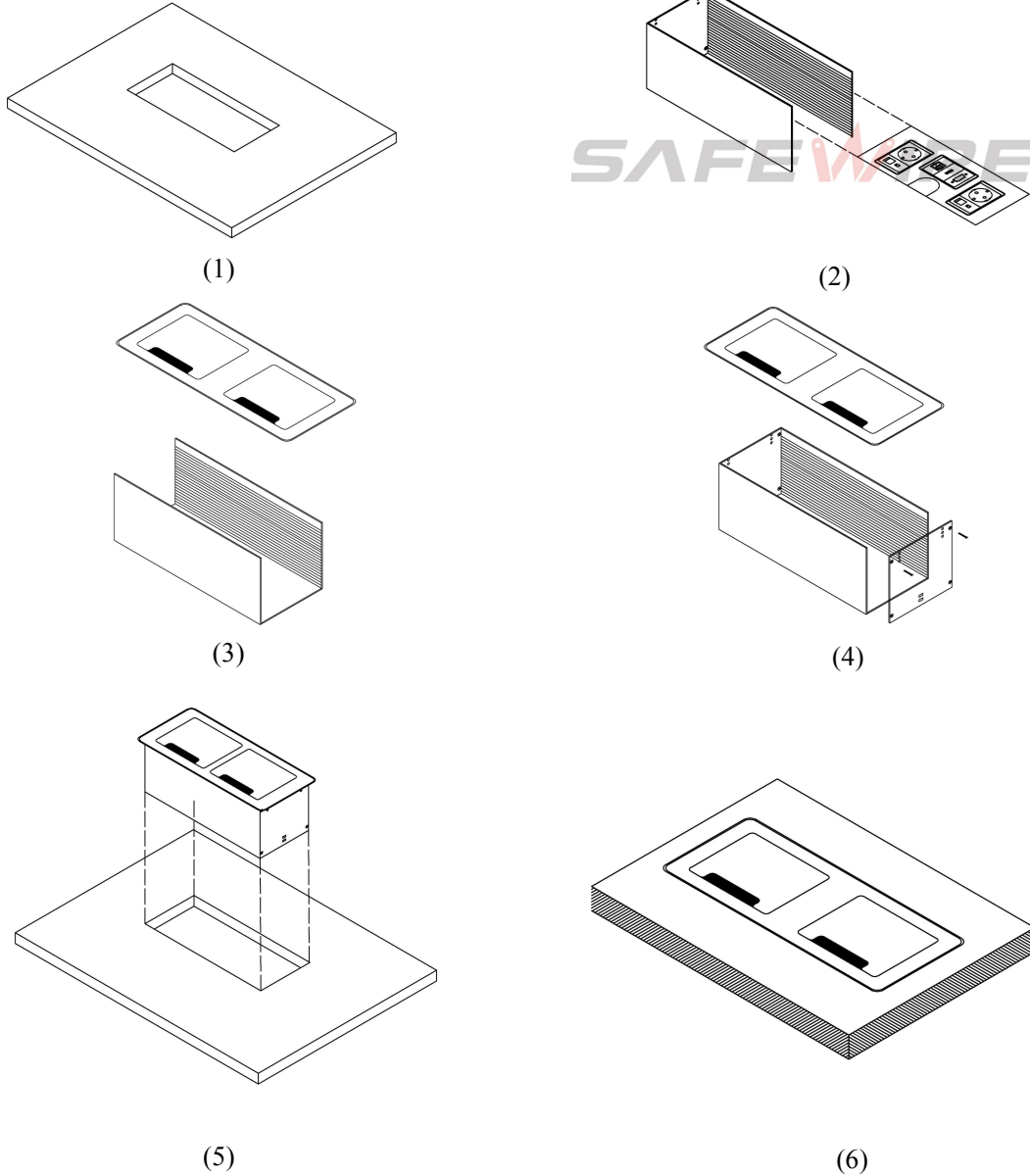

1. Before installation, please opening pore on the table-board which is asked to install according to related product specification.(unit:mm)
- 2.Load the function key panel into a base box.
- 3.Secure the panel and bottom box
- 4.Secure the surrounding bottom box with eight screws
- 5.Place the product in a pre-opened table top



## Wenzhou Safewire Electric Co.,Ltd.

No.152 Xingguang Road, Xingguang industry zone, Liushi town, Yueqing, Wenzhou,China ,325604  
Tel:0086-577-62799688; Email:info@safewirele.com;

[www.safewirele.com](http://www.safewirele.com)

---

### **Attentions:**

- 1.Use only in normal temperature.Do not expose to conditions that harm to the product's safety,such as humidity,dusty and corrosives.
- 2.Properly connecting and installing according to the rated voltage ,frequency,rated current and function identification of the product
3. All dimension quoted are nominal only. Drawings , images and text are for illustrative perposes only and product details and dimension are subject to change without notice.

### **Safety Warning:**

- 1)This is a class I product and must be earthed.
- 2)This product must be installed/wired by a qualified electrician.
- 3)before installation/maintenance ,ensure the mains supply is switched off and the circuit fuses are removed or circuit breakers switch off.
- 4)For indoor use only.