



Wenzhou Safewire Electric Co.,Ltd.
No.152 Xingguang Road, Xingguang industry zone, Liushi town, Yueqing, Wenzhou,China ,325604
Tel:0086-577-62799688; Email:info@safewirele.com;
www.safewirele.com

Wenzhou Safewire Electric CO.,Ltd.

SPECIFICATION SHEET

PRODUCT NAME: Desktop socket
PRODUCT No. : FZ-515



FZ-515

ADD: 152 xingguang industrial zone, yueqing city, zhejiang province
(TEL) :0086-577-62799688
(E-mail): info@safewirele.com
(WEB): <http://www.safewirele.com>



Wenzhou Safewire Electric Co.,Ltd.

No.152 Xingguang Road, Xingguang industry zone, Liushi town, Yueqing, Wenzhou,China ,325604
Tel:0086-577-62799688; Email:info@safewirele.com;

www.safewirele.com

Technical parameters & characteristic :

1) Working environment:

1. The environment temperature:-5°C~/40°C
2. The rated voltage : 100V~~250V
3. Rated current : 10A、 13A、 16A、 20A

2) Characteristic:

1	Model	FZ-517	6	HS Code	8536690000
2	Brand Name	Safewire or OEM brand	7	Market standard	Customized
3	Type	Desktop socket	8	Place of origin	Zhejiang , Wenzhou, China
4	Color	Silver/black/white	9	Frequency	50Hz~60Hz
5	Grounding	Standard grounding	10	Current Type	AC

3) Technical parameters :

Serial No.	Parameter	Description
1	Material	Zinc Alloy/Steel
2	Panel Material	Aluminum alloy
3	Surface finish	Electroplated/Painted/Power sprayed
4	Panel Dimension(mm)	170*123
5	Cutout(mm)	148*115
6	Height of product(mm)	97.6
7	Bottom box size(mm)	146*113*97.6
8	Bottom box material	Plastic
9	Capacity of modules /Interface size	4 ways 45*45mm modules
10	Configuration	Power outlet+Data outlet or USB charging : Customized as required
11	Cable length	1.5m, 2m,2m or required length
12	Available modules	45*45mm Type series

Application:

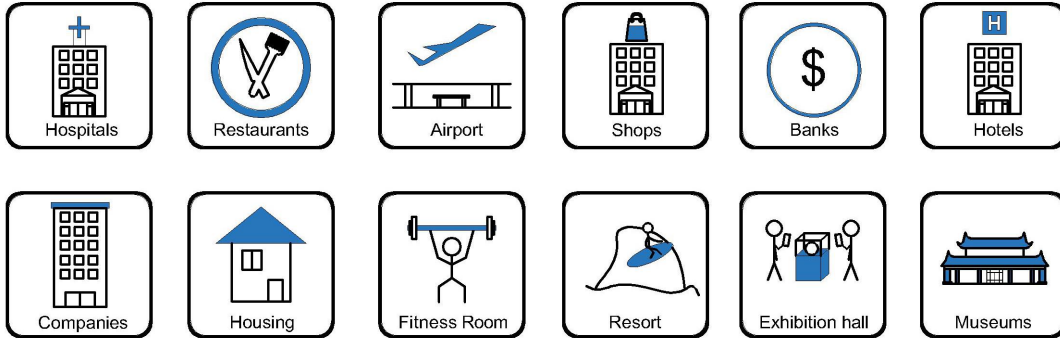

- Office and education
- Industry and Engineering
- Presentation and retail;
- Orientation and safety;
- Transit areas and parking;
- Hotels, hospitality and wellness;
- Health, sport and leisure;
- Art and culture;

CE certificate by TUV,Germany

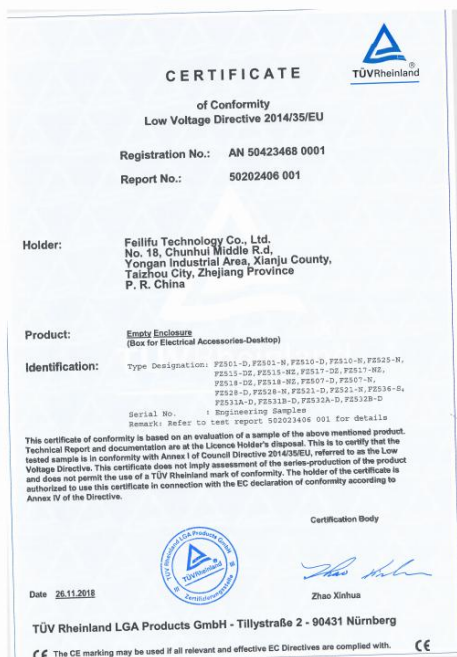

LVD test report

TEST REPORT	
Report No.:	50202406 001
Applicant's name:	Feilifu Technology Co., Ltd.
Applicant's address:	No.18, Chunhui Middle Road, Yongan Industrial Zone, Xianju County, Taizhou City, Zhejiang Province, China
Sample description:	Empty Enclosure (Box for Electrical Accessories-Desktop)
Model:	FZ501-D, FZ501-N, FZ507-D, FZ507-N, FZ510-D, FZ510-N, FZ515-DZ, FZ515-NZ, FZ517-DZ, FZ517-NZ, FZ518-DZ, FZ518-NZ, FZ528-D, FZ528-N, FZ521-D, FZ521-N, FZ525-N, FZ531A-D, FZ531B-D, FZ532A-D, FZ532B-D, FZ536-S
Date of receipt of test item:	Refer to cover page
Test location:	Room 02, The 2nd floor No.201, GRG Technological Building, 163 Ping Yun Rd, Tianhe District, Guangzhou, China
Test standard:	EN 60670-1:2005+A1:2013
Test date(s):	Refer to cover page
Test result:	The test results are in compliance with the above mentioned standards.
Date of issue:	Refer to cover page
Other aspects:	/
N/A	
Abbreviations:	P = passed; F = failed; N/A = not applicable

Product Show:























Features:

- 1) With damping device, press button and pop up with slow speed;
- 2) With screws and complete plastic bottom box,more easy to installation;
- 3) The panel is by aluminum alloy of integrate diecasting structure, more reliable surface protect from scratch ;
- 4) Silver or black painting finish of optional surface .

Available for 45*45mm type international sockets or modules types:

SAFEWIRE

45 Type Function Accessories

								
F2	F3	F4	F11	F15	F16	F18		
								
RJ45/Cat.6 data/TEL socket	TV socket	BNC socket	3.5 earphone socket	DIN(eight pins) socket	Audio socket	Video socket	Stereo socket	USB
F20/F21/F22/F23/F25/F28	F50	F51	F52	F53	F55	F56	F58	F59
								
F60	F62	F65/F66/F67/F68	F68	F71				

FZ-515 Outline drawing:

SAFEWIRE

FZ-515 outline

Units:mm

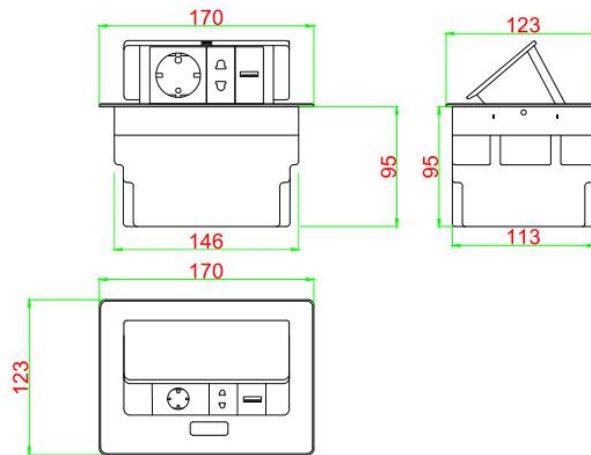

Package:20 Pcs inner box into a master carton.Poly bag with box packing.

SafeWire

Package solution



Installation Process

1. Cut out as specification sheet.
2. put the bottom box into cut-out hole,punch the self-tapping screw and fix the bottom box.
3. Remove plastic frame fixing socket modules.Assembly the socket or data Jack into the plastic frame and press frame ensure them combine tightly.
4. Keep socket modules connected by inner wire (it should be copper core 1.5mm²9~20 wire and length should be suitable).Then earthing and ensure inner wire tightly with modules.For fast connector terminal block,Just insert wire into block.
5. Phone line ,TV receiving line sound box wire (it should thin wire) Just the wire length and tighten stop screw comathen.
6. Put the panel on the bottom box and it with the hole.

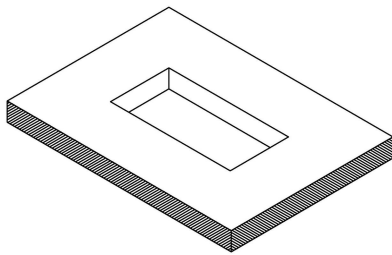

(1)



(2)

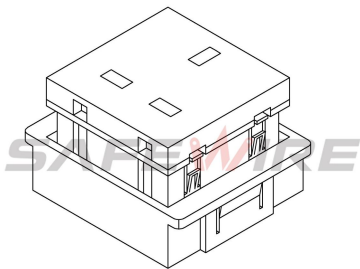

(3)

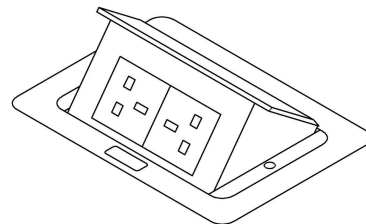

(4)

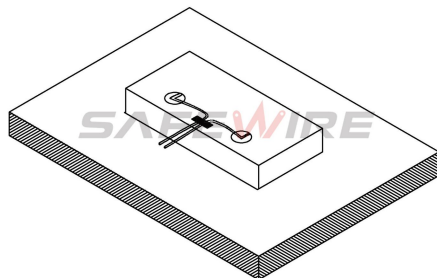

(5)

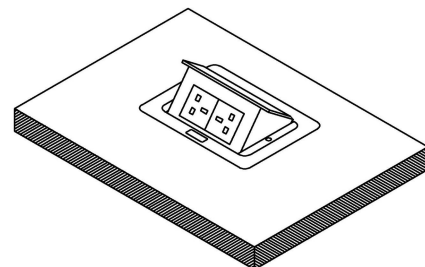

(6)

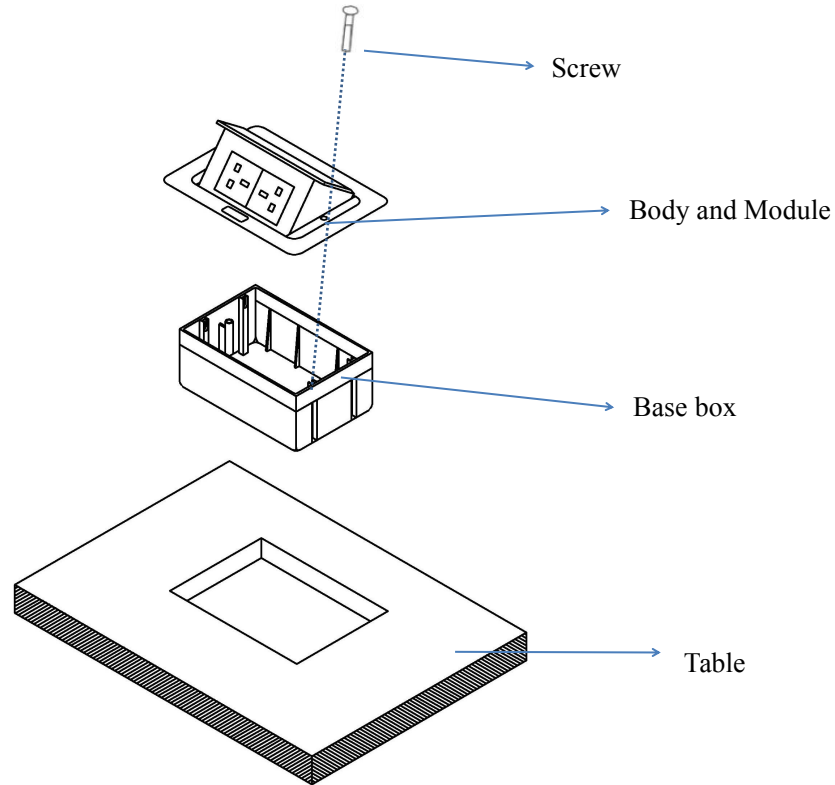

(Image is for reference)

Attentions:

- 1.Prevent from corrosive liquid, gas (strong acid, strong alkali, paint)and humidity.
2. All dimension quoted are nominal only. Drawings , images and text are for illustrative purposes only and product details and dimension are subject to change without notice.

Safety Warning:

- 1)This is a class I product and must be earthed
- 2)This product must be installed/wired by a qualified electrician
- 3)before installation/maintenance ,ensure the mains supply is switched off and the circuit fuses are removed or circuit breakers switch off
- 4)For indoor use only