



Wenzhou Safewire Electric Co.,Ltd.

No.152 Xingguang Road, Xingguang industry zone, Liushi town, Yueqing, Wenzhou,China ,325604

Wenzhou Safewire Electric CO.,Ltd.

SPECIFICATION SHEET

PRODUCT NAME: Pop up floor socket

PRODUCT No. : HTD-18

ADD: 152 xinguang industrial zone, yueqing city, zhejiang province

(TEL) :0086-577-62799688

(E-mail) : info@safewirele.com

(WEB): <http://www.safewirele.com>



Technical parameters:

1. The environment temperature: $-5^{\circ}\text{C}\sim/40^{\circ}\text{C}$
2. The rated voltage : 100V $\sim\sim$ 250V
3. Rated current : 10A、 13A、 16A、 20A



Wenzhou Safewire Electric Co.,Ltd.

No.152 Xingguang Road, Xingguang industry zone, Liushi town, Yueqing, Wenzhou,China ,325604

1	Model	HTD-18	7	Market standard	Customize d
2	Brand Name	Safewire or OEM brand	8	Place of origin	Zhejiang , Wenzhou, China
3	Type	floor socket	9	Frequency	50Hz~60Hz
4	Color	Golden, silver	10	Current Type	AC
5	Grounding	Standard grounding			
6	HS Code	8536690000			



Wenzhou Safewire Electric Co.,Ltd.

No.152 Xingguang Road, Xingguang industry zone, Liushi town, Yueqing, Wenzhou,China ,325604

Serial No.	Parameter	Description
1	Panel Material	Brass alloy/Alu alloy
2	Surface finish	Wire drawing/Polishing/Spray painting
3	Panel Dimension(mm)	128*120
4	Cutout(mm)	100x100
5	Capacity of modules	3 ways modules
6	Bracket material	Zinc Alloy & Alu Alloy
7	Sink box Thickness	1.2mm
8	Sink box Material	Steel+Zinc plated
9	Available modules	45*45/22.5*45 (mm)
10	Damping device (DP)	Normal Pop-up & Soft Pop-up available
11	N.W(kg)	1.00 (Brass alloy);0.76(Alu alloy)
12	G.W(kg)	20.8 (Brass alloy);15.8(Alu alloy)
13	Carton size(cm)	41.5x27x27

Application :

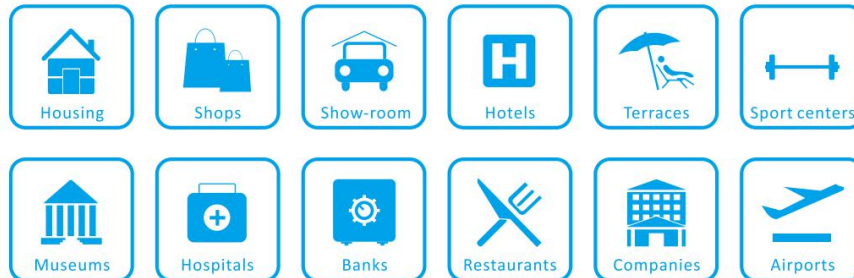

- Office and education
- Industry and Engineering
- Presentation and retail;
- Orientation and safety;
- Transit areas and parking;
- Hotels, hospitality and wellness;
- Health, sport and leisure;
- Art and culture;





Installation instructions:

1. Remove the panel from the bottom box along with the electrical modules.
2. Fix the flooring with spare screws on the bottom box and place it in the embedded hole.
3. The flooring surface shall be at least level with the ground or 20mm below the ground.
4. Remove flooring surface ,Insert the 10--12mm lead head into the terminal of floor box.
5. Fix the panel to the bottom box with screws.



Attentions:

1. Dispose of trash in bottom box and prevent dirt and debris from entering inside.
- 2.The sealing ring is closely attached to the smooth surface to prevent water leakage.
- 3.Prevent from alkaline corrosion and humidity.
- 4.When installing, pay attention to the opening direction,the length of the conductor to the bottom box shall not exceed 10cm,Set aside at least 200mm of cable.
- 5.When installing and wiring,Product should avoid direct contact with corrosive liquid, gas (strong acid, strong alkali, paint).
6. This product is suitable for dry surface treatment, avoid water flush and immersion, and ensure its insulation
7. Avoid acid alkaline solution flushing,avoid scratch of transparent protective paint,ensure corrosion resistance.



SAFEWIRE

Wenzhou Safewire Electric Co.,Ltd.

No.152 Xingguang Road, Xingguang industry zone, Liushi town, Yueqing, Wenzhou,China ,325604



Package:20 Pcs inner box into a master carton.Poly bag with box packing.

Method of use:

Hold the lid down with your hand,Pull the push button as the direction, Panel popup.



SAFEWIRE

Wenzhou Safewire Electric Co.,Ltd.

No.152 Xingguang Road, Xingguang industry zone, Liushi town, Yueqing, Wenzhou,China ,325604

Product Show:



Features:

1.The button of open floor outlet is enough big and it is easy to start

2.Easy to install and disassembly this electrical accessories without need any tools. Furthermore, it is more optional for fast connect wire for terminal block as fast wiring connection.

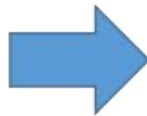
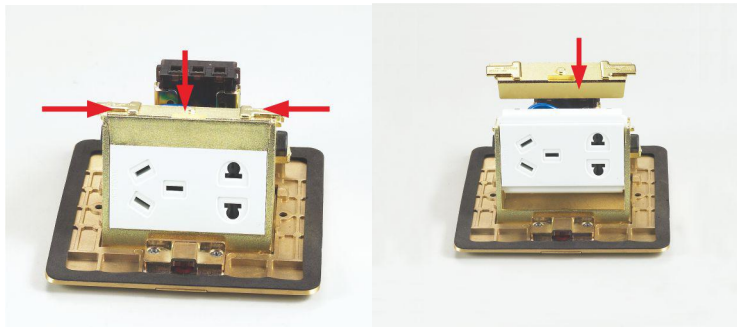

3. More Strong Scratch Resistance: Surface finish made from

stainless steel or Brass by combination of tough material, Aluminum (ADC12) and shot blast finish on the surface achieves high scratch resistance.

4.durable socket receptacle:Using elastic phosphor copper avoids playing spark plug and plug set to bit dead ,ensure high conductivity and more life of pulling and plugging over 15000 times.PC+ABS(1.Modules fireproof : 850 degree C temp.;; 2.Modules don't distortion under 102 degree C temp.; 3.Stand under 15 degree C temp) ;Oxygen Insulation & Fire resistance in accordance with UL94 international standard.

5. Long lifetime of push button: Compared to similiar products,more than 5000 times of push button.

6.More soft and slow damping device:The damping speed of our device is 10 times slower than similiar products.Our damping have been patented

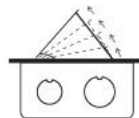

10 Times

The floor socket equipped with soft starting device, the opening speed of which is 20 times slower than regular products.
State for opening: uniform speed, slow.

7. More heavy duty of bottom boxes:Thickness of bottom boxes body is over 1mm.

HTD-18 Outline drawing:

SAFEWIRE

HTD-18 outline



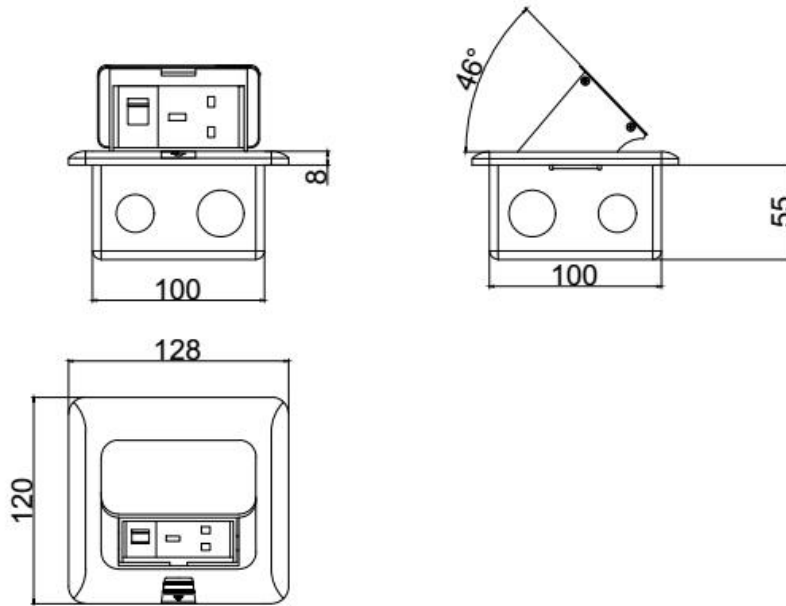

















Units: mm



Available sockets or modules types:

SAFEWIRE

45 Type Function Accessories

								
F2	F3	F4	F11	F15	F16	F18		
								
F20/F21/F22/F23/F25/F28	F30	F31	F32	F33	F35	F36	F38	F39
								
F60	F62	F65/F66/F67/F68	F68	F71				