

Wenzhou Safewire Electric CO.,Ltd.

# SPECIFICATION SHEET

**PRODUCT NAME:** Pop up floor socket

**PRODUCT No. :** HTD-1



ADD: 152 xinguang industrial zone, yueqing city, zhejiang province

(TEL) :0086-577-62799688

(E-mail) : info@safewirele.com

(WEB): <http://www.safewirele.com>



**Technical parameters & characteristic :**

**1) Working environment:**

1. The environment temperature:-5°C~/40°C
2. The rated voltage : 100V~~250V
3. Rated current : 10A、 13A、 16A、 20A

**2) Characteristic:**

<b>1</b>	<b>Model</b>	<b>HTD-1</b>	<b>6</b>	<b>HS Code</b>	8536690000
<b>2</b>	<b>Brand Name</b>	Safewire or OEM brand	<b>7</b>	<b>Market standard</b>	<b>Customized</b>
<b>3</b>	<b>Type</b>	floor socket	<b>8</b>	<b>Place of origin</b>	Zhejiang , Wenzhou, China
<b>4</b>	<b>Color</b>	Golden, silver	<b>9</b>	<b>Frequency</b>	50Hz~60Hz
<b>5</b>	<b>Grounding</b>	Standard grounding	<b>10</b>	<b>Current Type</b>	AC

**3) Technical parameters :**

Serial No.	Parameter	Description
<b>1</b>	<b>Panel Material</b>	Brass alloy/Alu alloy
<b>2</b>	<b>Surface finish</b>	Wire drawing/Polishing/Spray painting
<b>3</b>	<b>Panel Dimension(mm)</b>	120*120
<b>4</b>	<b>Cutout(mm)</b>	103x103
<b>5</b>	<b>Capacity of modules</b>	3 ways modules
<b>6</b>	<b>Bracket material</b>	Zinc Alloy & Alu Alloy
<b>7</b>	<b>Sink box Material</b>	Steel+Zinc plated
<b>8</b>	<b>Sink box Thickness:</b>	1.2mm
<b>9</b>	<b>Available modules:</b>	45*45/45*22.5(mm)
<b>10</b>	<b>Damping device (DP):</b>	Normal Pop-up & Soft Pop-up available
<b>11</b>	<b>N.W(kg)</b>	0.89(Brass alloy);0.72(Alu alloy)
<b>12</b>	<b>G.W(kg)</b>	18.6 (Brass alloy);15.2(Alu alloy)
<b>13</b>	<b>Carton size(cm)</b>	44x28x27.3

**Application:**

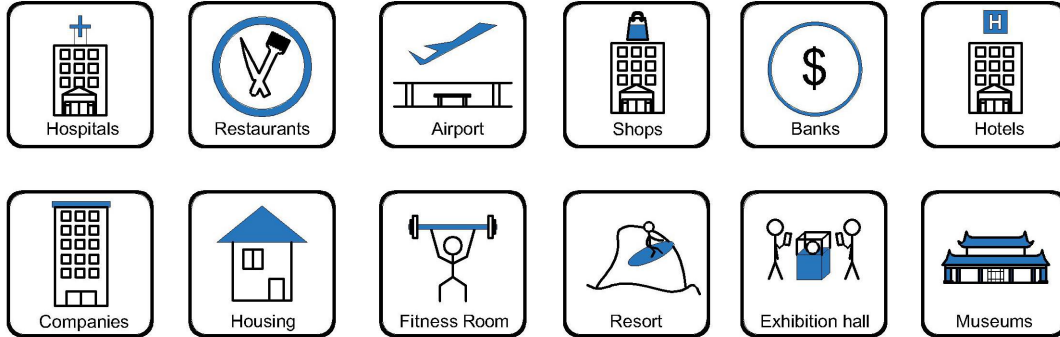

- Office and education
- Industry and Engineering
- Presentation and retail;
- Orientation and safety;
- Transit areas and parking;
- Hotels, hospitality and wellness;
- Health, sport and leisure;
- Art and culture;

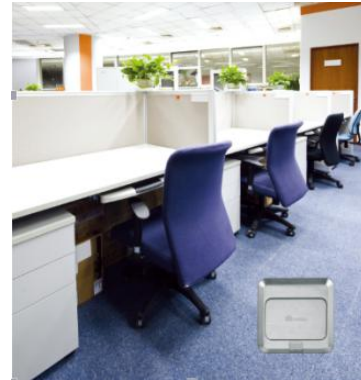

**CE certificate by TUV,Germany**

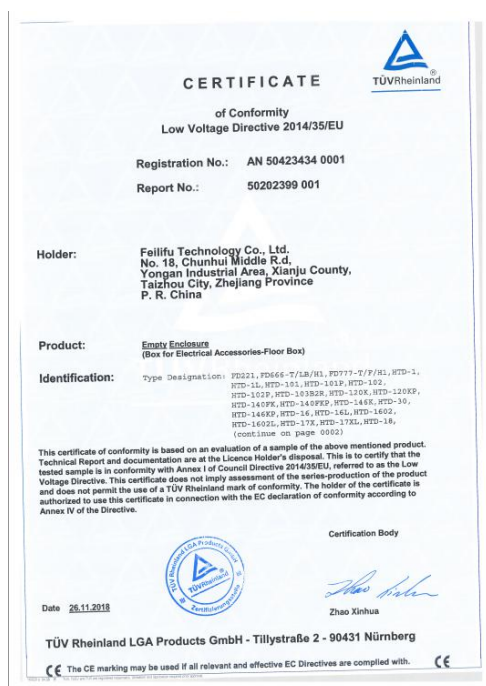

**LVD test report**

TEST REPORT	
Report No. ....	50202399 001
Applicant's name. ....	Feliifu Technology Co., Ltd.
Applicant's address. ....	No. 18, Chunhui Middle Road, Yongan Industrial Zone, Xianju County, Taizhou City, Zhejiang Province, China
Sample description. ....	Empty Enclosure (Box for Electrical Accessories-Floor Box)
Model. ....	HTD-1, HTD-1L, HTD-101, HTD-101P, HTD-102, HTD-102P, HTD-10382R, HTD-120K, HTD-120KP, HTD-140FK, HTD-140FKP, HTD-146K, HTD-146KP, HTD-16, HTD-16L, HTD-1602, HTD-1602L, HTD-17X, HTD-17XL, HTD-18, HTD-18L, HTD-180K, HTD-180KP, HTD-2, HTD-2P, HTD-210CK, HTD-210CKP, HTD-26, HTD-26L, HTD-28, HTD-28L, HTD-3, HTD-3P, HTD-30, HTD-40, HTD-71, HTD-71L, HTD-140YK, HTD-140YKP, FD221, FD466-TALB/H1, FD777-T/F/H1
Date of receipt of test item. ....	Refer to cover page
Test location. ....	Room 02, The 2nd floor No.201, GRG Technological Building, 163 Ping Yun Rd, Tianhe District, Guangzhou, China
Test standard. ....	EN 60670-23:2008 in conjunction with EN 60670-1:2005
Test date(s). ....	Refer to cover page
Test result. ....	The test results are in compliance with the above mentioned standards.
Date of issue. ....	Refer to cover page
Other aspects. ....	/
Abbreviations: P = passed; F = failed; NA = not applicable	

**Product Show:**



Silver color



Brass color



Bottom box

**Features:**

**1.Easy to install:** Fast connect wire for terminal block as fast wiring connection.

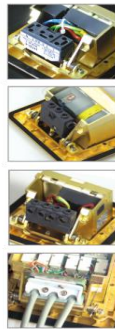

**2. More Strong Scratch Resistance:** Surface finish made from Brass ( H62 ) by combination of tough material, Aluminum (6061) .

**3.durable socket receptacle:**Using elastic phosphor copper , high conductivity ,pulling and plugging over 15000 times.PC+ABS fireproof : 850 degree C temp.; Oxygen Insulation & Fire

resistance in accordance with UL94 standard.

**4. Long lifetime of push button:** ,more than 5000 times of push button.

**5.More soft and slow damping device:**The damping speed of our device is 10 times slower than simliar products.Our damping have been patented

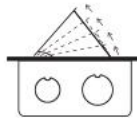

**10 Times**





















The floor socket equipped with soft starting device, the opening speed of which is 20 times slower than regular products.  
State for opening: uniform speed, slow.

**7.More heavy duty of bottom boxes:**Thickness of bottom boxes body is over 1mm.

Available for F type 45\*45mm type or D type23\*26mm international sockets or modules types:

**SAFEWIRE**

45 Type Function Accessories

 2 pin socket F2	 3 pin USA socket F3	 3 pin multi function F4	 EU socket F11	 EU socket F13	 Floor socket F16	 USA socket F18
 Euro/Car/UK socket F10	 TV socket F12	 BNC socket F14	 RJ45 ethernet socket F15	 DIN socket F17	 Audio socket F19	 Video socket F20
 Common socket F21	 Speaker socket F22	 15 pin USA socket F23	 HD TV socket F24	 Solenoid F25	 RJ45 ethernet socket F26	 RJ45 ethernet socket F27



**SAFEWIRE**

Wenzhou Safewire Electric Co.,Ltd.

No.152 Xingguang Road, Xingguang industry zone, Liushi town, Yueqing, Wenzhou,China ,325604

**HTD-1 Outline drawing:**

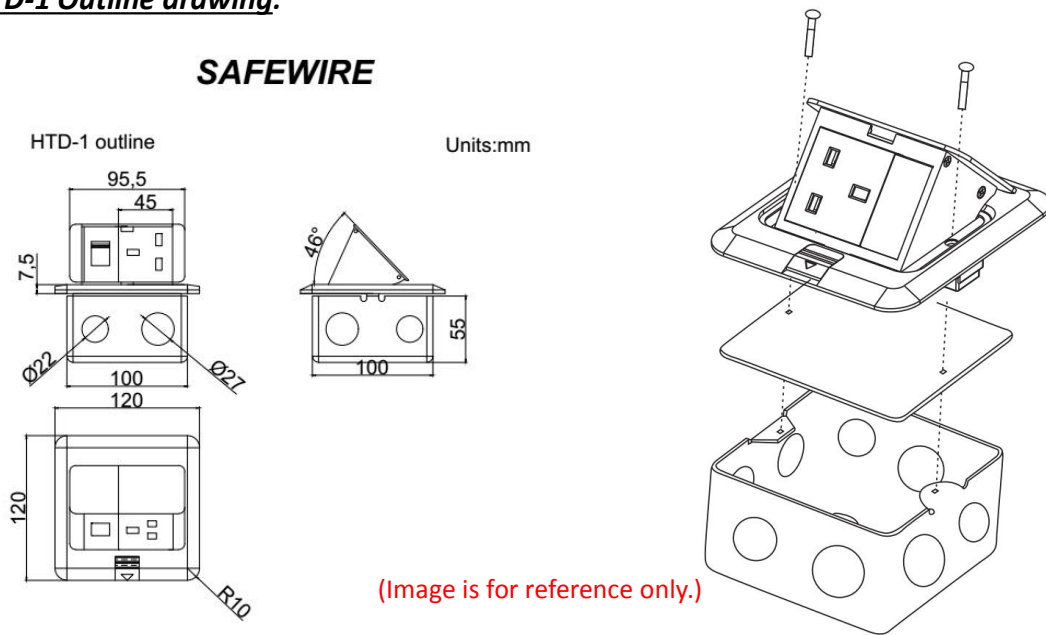

**Package:**20 Pcs inner box into a master carton.Poly bag with box packing.

**SafeWire**

Package solution

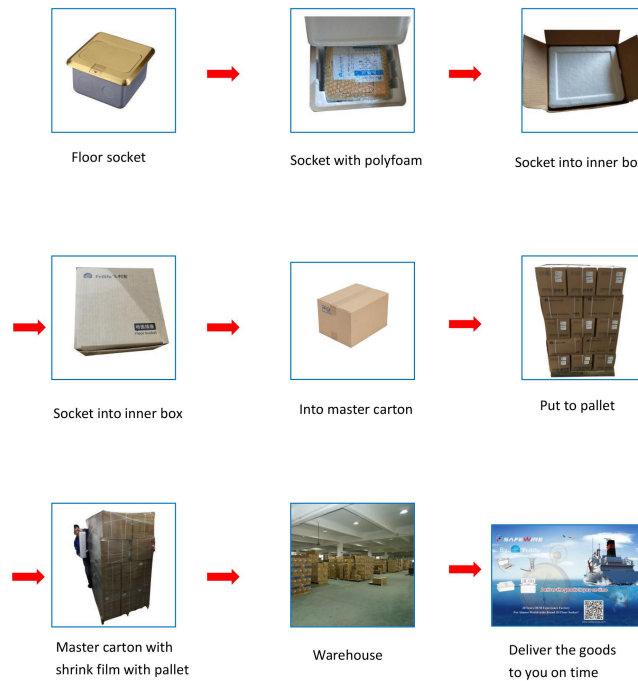

[www.safewirele.com](http://www.safewirele.com)

### **Installation Guide**

1. Cut out size : 120\*120mm.Install the bottom box with panel into the specified location.
2. Screw mounting frame and panel(for desktop only).
3. Fix the panel and bottom box with screws(This item is for ground installation only).
4. ADjust the tightness of all wiring lines (no influence on opening).

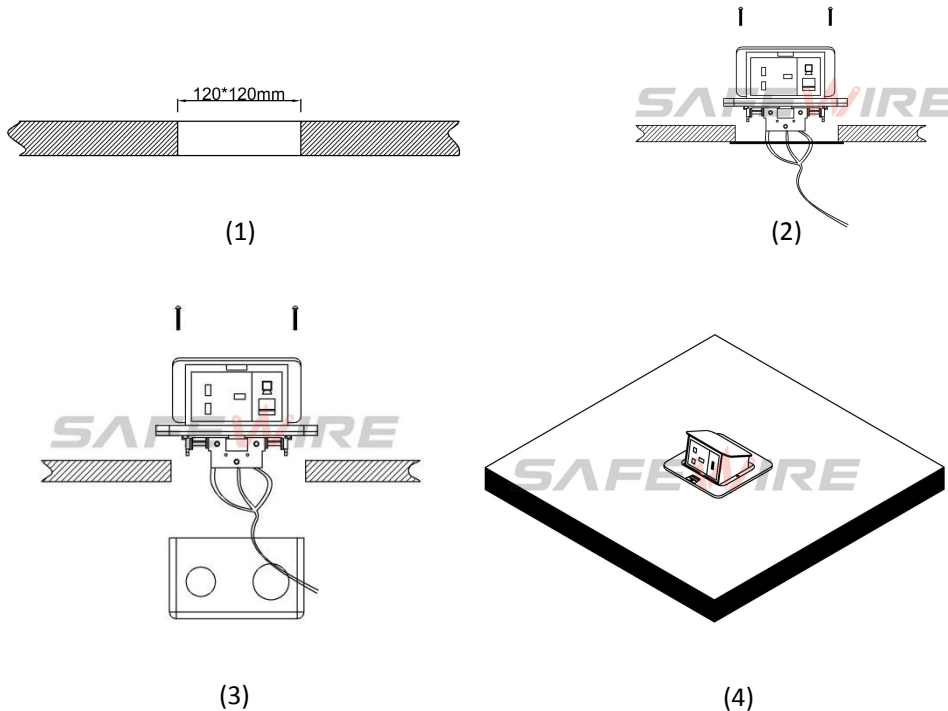

### **Attentions:**

- 1.Dispose of trash in bottom box and prevent dirt and debris from entering inside.
- 2.Prevent from corrosive liquid, gas (strong acid, strong alkali, paint)and humidity.
- 3.When installing, pay attention to the opening direction,the length of the conductor to the bottom box shall not exceed 10cm,Set aside at least 200mm of cable.
4. All dimension quoted are nominal only. Drawings , images and text are for illustrative perposes only and product details and dimension are subject to change without notice.
- 5.Make sure that the sealing under plate will be jointed tightly with the earth's surface,avoiding seepage

### **Safety Warning:**

- 1.This is a class I product and must be earthed
- 2.This product must be installed/wired by a qualified electrician
- 3.For indoor use only.
- 4.For concrete floor.