



Wenzhou Safewire Electric Co.,Ltd.

No.152 Xingguang Road, Xingguang industry zone, Liushi town, Yueqing, Wenzhou,China ,325604  
Tel:0086-577-62799688; Email:info@safewirele.com;

[www.safewirele.com](http://www.safewirele.com)

---

Wenzhou Safewire Electric CO.,Ltd.

## SPECIFICATION SHEET

**PRODUCT NAME:**            **Desktop socket**

**PRODUCT No. :**            **FZ-531**

ADD: 152 xinguang industrial zone, yueqing city, zhejiang province

(TEL) :0086-577-62799688

(E-mail): info@safewirele.com

(WEB): <http://www.safewirele.com>



Wenzhou Safewire Electric Co.,Ltd.

No.152 Xingguang Road, Xingguang industry zone, Liushi town, Yueqing, Wenzhou,China ,325604  
Tel:0086-577-62799688; Email:info@safewirele.com;

[www.safewirele.com](http://www.safewirele.com)

---

## Product image/picture



**Model: FS-531A/FZ-531B-D**

Brand Name : Safewire or OEM brand

Place of origin : Zhejiang ,Wenzhou,China

Rated Current :10-25A

Type: Pole/Mini-columns

Current Type: AC

HS Code : 8536690000

Frequency:50Hz~60Hz

Grounding : Standard grounding

Voltage:110~240V

Color :Silver

Market standard: Customized



Wenzhou Safewire Electric Co.,Ltd.

No.152 Xingguang Road, Xingguang industry zone, Liushi town, Yueqing, Wenzhou,China ,325604  
Tel:0086-577-62799688; Email:info@safewirele.com;

[www.safewirele.com](http://www.safewirele.com)

Serial No.	Parameter	Description
1	Power supply side	Single side
2	Panel Material	Aluminum alloy
3	Surface finish	Painted/Brushed Oxygenated
4	Height of product(mm)	350 for FZ-531A
5	Height of product(mm)	660 for FZ-531B
6	dimension (mm)	R73.5*147*135.3
	Capacity of modules	45*45mm modules
7	Configuration	Power outlet+Data outlet or USB charging+HDMI+VGA+Audio socket : Customized as required
8	Available modules:	45*45mm Type series



Wenzhou Safewire Electric Co.,Ltd.

No.152 Xingguang Road, Xingguang industry zone, Liushi town, Yueqing, Wenzhou,China ,325604  
Tel:0086-577-62799688; Email:info@safewirele.com;

[www.safewirele.com](http://www.safewirele.com)

---

## **Application:**



Application for Offices/Business/Premises/Car parks/Industrial buildings/Warehouse/Mechanical workshops.

## **Packaging & Delivery**

Inner packing box

Outer exporting carton



Wenzhou Safewire Electric Co.,Ltd.

No.152 Xingguang Road, Xingguang industry zone, Liushi town, Yueqing, Wenzhou,China ,325604  
Tel:0086-577-62799688; Email:info@safewirele.com;

[www.safewirele.com](http://www.safewirele.com)

---



## **Features:**

- 1) Simplicity: The column is secured to the ceiling or floor by pressure , no need for screwing to the ground or the ceiling.
- 2) Installation mobility: The columns are secured by pressure on the floor. They do not have to be bolted to the floor and it is therefore very easy to reconfigure the distribution of workplaces.
- 3) Compact: The mini-columns are supplied all necessary materials for installation: foot for floor attachment, top and side covers and fastenings.
- 4) Customization solution: Flush-mount power supply or power supply through floor trunking are optional; two shape of oval or square is



Wenzhou Safewire Electric Co.,Ltd.

No.152 Xingguang Road, Xingguang industry zone, Liushi town, Yueqing, Wenzhou,China ,325604  
Tel:0086-577-62799688; Email:info@safewirele.com;

[www.safewirele.com](http://www.safewirele.com)

---

optional;different configuration and electrical sockets and plates is optional;

5) 1 side power supply;

## **Product Show:**





**SAFEWIRE**

Wenzhou Safewire Electric Co.,Ltd.

No.152 Xingguang Road, Xingguang industry zone, Liushi town, Yueqing, Wenzhou,China ,325604  
Tel:0086-577-62799688; Email:info@safewirele.com;

[www.safewirele.com](http://www.safewirele.com)

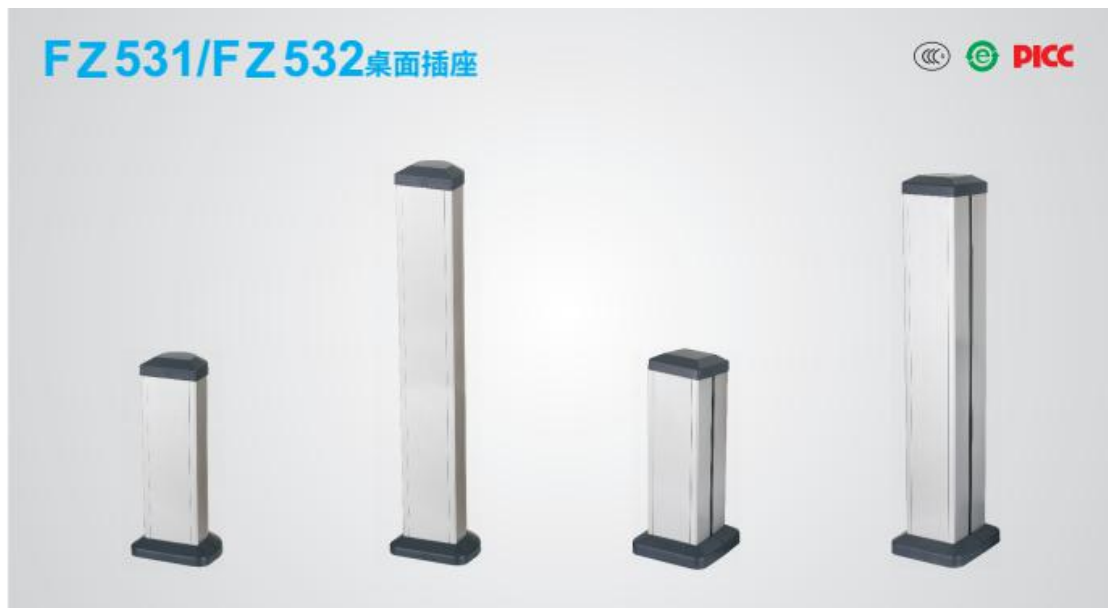

**Product drawing:**

FZ-531A



# Wenzhou Safewire Electric Co.,Ltd.

No.152 Xingguang Road, Xingguang industry zone, Liushi town, Yueqing, Wenzhou,China ,325604  
Tel:0086-577-62799688; Email:info@safewirele.com;

[www.safewirele.com](http://www.safewirele.com)

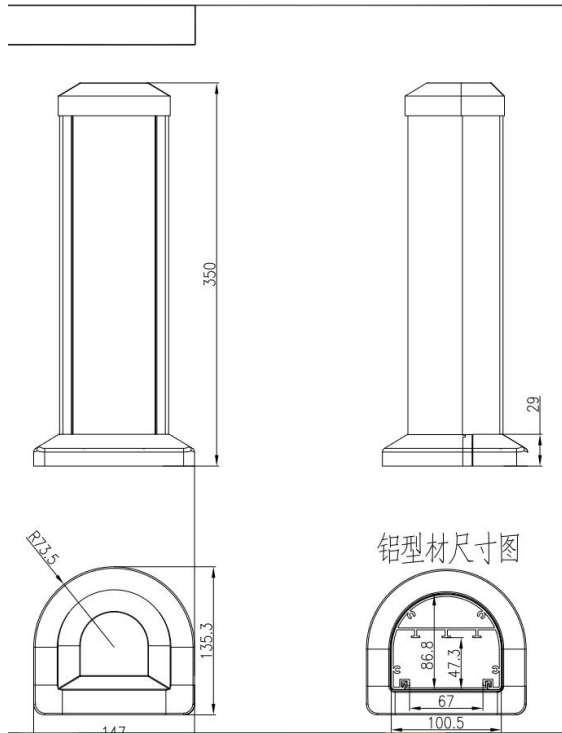

## FZ-531B

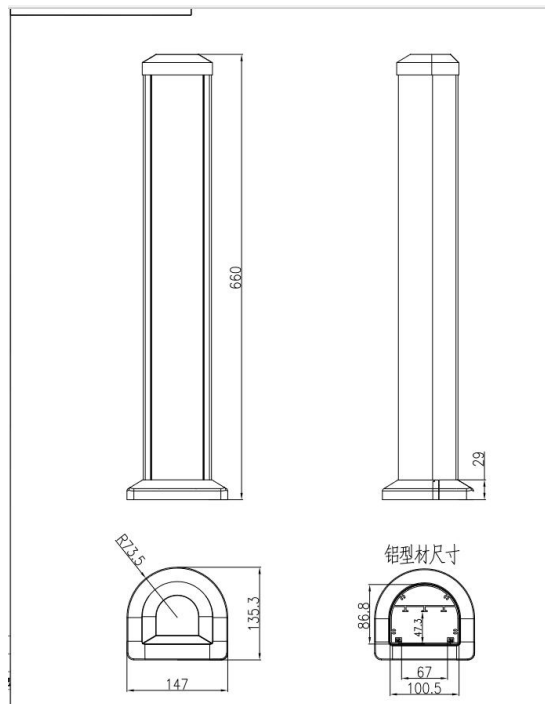



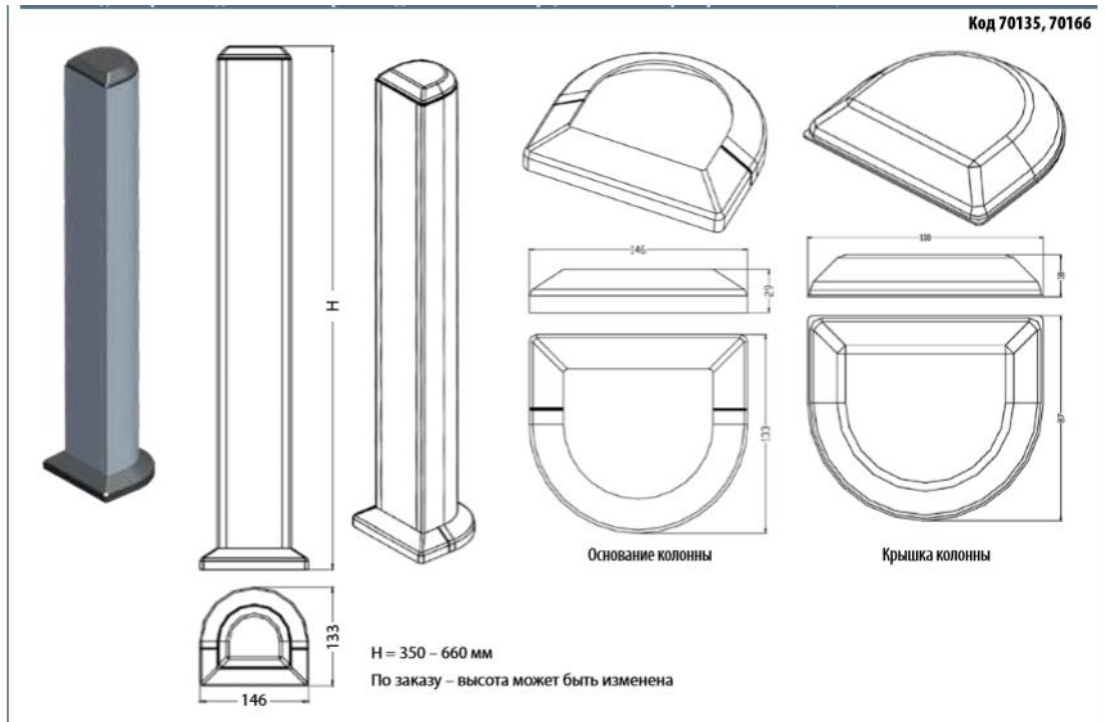























Available sockets or modules types:

**SAFEWIRE**

45 Type Function Accessories

									
2 pin socket	3 pin 10A socket	3 pin multi function	BS socket	EU socket	French socket	USA socket			
F2	F3	F4	F11	F15	F16	F18			
									
RJ45/Cat.6 data/TEL socket	TV socket	BNC socket	g3.5 earphone socket	DIN(eight pins)	Audio socket	Video socket	Stereo socket	USB	
F20/F21/F22/F23/F25/F28	F50	F51	F52	F53	F55	F56	F58	F59	
									
Cannon socket	Speaker socket	15 pins VGA (pin /hole type) / 9pins VGA(pin / hole type)	HD TV socket	S-terminal					
F60	F62	F65/F66/F67/F68	F68	F71					