

Desktop Socket

Floor Socket

Accessories

Switch



45x45mm Module as Specification Legrand's Mosaic Series

Features:

1. Plastic Material Bayer 2805 PC(UL94V-0)
2. Shutter door :The shutter prevent accidental electric shock . The single pole can bear max 4KGF pressure;
3. Inserts inside:0.6mm thickness elastic phosphor copper avoids playing spark plug and plug set to bit dead ,ensure high conductivity , life of pulling and plugging over 15000 times.
4. Switch materials :Using silver-tin alloy or silver-nickel contacts, to strengthen conductivity of the switch;
5. More safety double pole: Socket with double pole auto switch type;
6. IEC60884 standard technical:Insulation strength as 100M Ω Min, test voltage as AC 2000V/Minute; contact Resistance: 50MΩ Max, Electronical life over 10000 min;
7. Easy-install modules design: One side two clip, four direction clip type;
8. Fast wiring: Screw type for fast wiring to save labor cost.

Product Picture	Item	Size (mm)	Description	Material	Product Picture	Item	Size (mm)	Description	Material
	F2	22.5x45	2 pin socket,10A, 250V	Polycarbonate		F3	45x45	3 pin 10A,220V;	Polycarbonate
	F4	45x45	3 pin multi function socket of 90 degree angle, 10A, 250V	Polycarbonate		F5	45x22.5	Swiss socket, 10A, 250V	Polycarbonate
	F8	22.5x45	USB charging, single port output 5VDC 2.1A, maximum charging current 1*2100mA, screw terminal, Support YD/T1591-2009, BC1.2, Apple and Samsung phone and IPAD.	Polycarbonate		F9	45x45	USB charging, dual port output 5VDC 2.1A, maximum charging current 1*2100mA, screw terminal, Support YD/T1591-2009, BC1.2, Apple and Samsung phone and IPAD.	Polycarbonate
	F11	45x45	BS socket, 13A, 250V; 2P+E with shutters socket;	Polycarbonate		F15	45x45	European socket(Schuko), 16A, 250V, Angle 0 degree or 90 degree, 2P+E, screw terminals;	Polycarbonate
	F15B	45x45	European socket(Schuko), 16A, 250V, Angle 45 degree, 2P+E, screw terminals;	Polycarbonate		F16	45x45	French Socket, 16A,250V	Polycarbonate
	F18	45x45	American socket, 16A, 250V; 2P+E with shutters socket;	Polycarbonate		F21	22.5x45	Cat 5e RJ45 socket with shutter;	Polycarbonate

Product Picture	Item	Size (mm)	Description	Material	Product Picture	Item	Size (mm)	Description	Material
	F21B	22.5x45	Cat 6 RJ45 socket with shutter;	Polycarbonate		F23	22.5x45	RJ11 Telephone socket with shutter, regular with 4 contact pins. 2 contact pins and 6 contact pins should be customization production.;	Polycarbonate
	F50	22.5x45	Single male TV socket;	Polycarbonate		F51	22.5x45	BNC socket	Polycarbonate
	F52	22.5x45	Φ3.5 earphone for audio/video connector, screw terminals	Polycarbonate		F53	22.5x45	DIN(eight pins)	Polycarbonate
	F55	22.5x45	Audio socket provide the stereo audio connect for device such as DVD drive, camera etc.;	Polycarbonate		F56	22.5x45	Video socket provide the video connect for device such as DVD drive, camera etc.;	Polycarbonate
	F58	22.5x45	Sound socket provide the stereo audio connect for device such as DVD drive, camera etc.;	Polycarbonate		F59	22.5x45	USB for data 2.0, screw terminal	Polycarbonate
	F60	22.5x45	Male Kalon socket, soldering connection	Polycarbonate		F62	22.5x45	Speaker socket, soldering connection;	Polycarbonate
	F65	22.5x45	15 Pins VGA (male type), RS232 socket, soldering connection	Polycarbonate		F66	22.5x45	15 Pins VGA (female type); RS232 socket, soldering connection	Polycarbonate
	F67	22.5x45	9 Pins VGA (male type), RS232 socket, soldering connection	Polycarbonate		F68	22.5x45	9 Pins VGA (female type); RS232 socket, soldering connection	Polycarbonate
	F69	22.5x45	HDMI, single HDMI socket with protective plug, 1 module size	Polycarbonate		F71	22.5x45	S terminal; soldering connection	Polycarbonate
	F81	45x22.5	2 way curve switch, 10A, 250V	Polycarbonate		F83	45x45	2 way switch, 10A, 250V	Polycarbonate
	F70	22.5x45	Empty plate; material: Polycarbonate; color:white	Polycarbonate		F80	45x22.5	1 way switch, 10A, 250V	Polycarbonate
	F82	45x45	1 way switch, 10A, 250V	Polycarbonate					

Desktop Socket

Floor Socket

Accessories

Switch

4. 45×45mm Legrand's Mosaic Series Module

Product mix

1 way

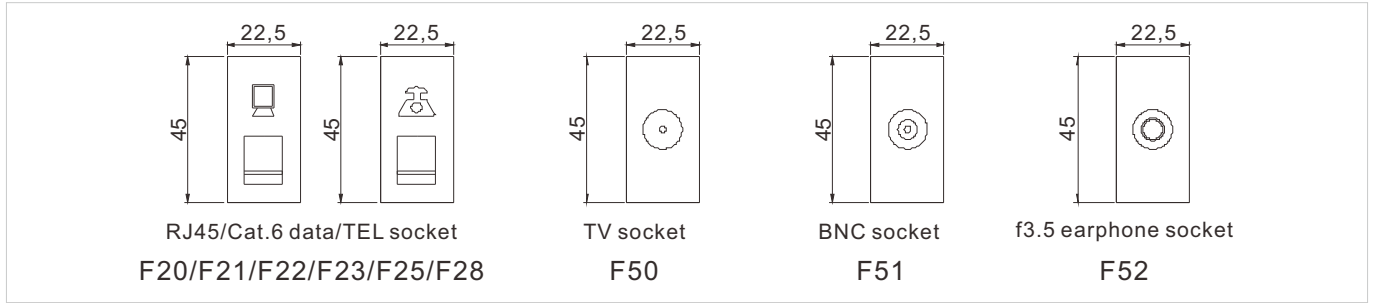

2 way

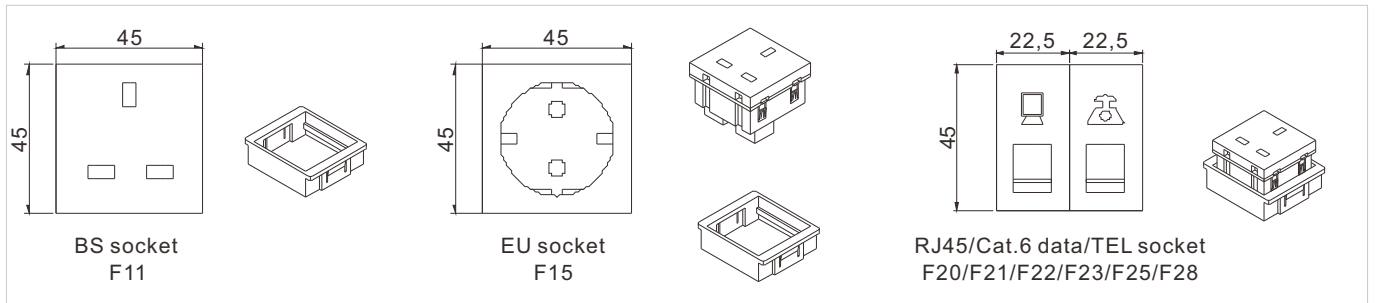

3 way

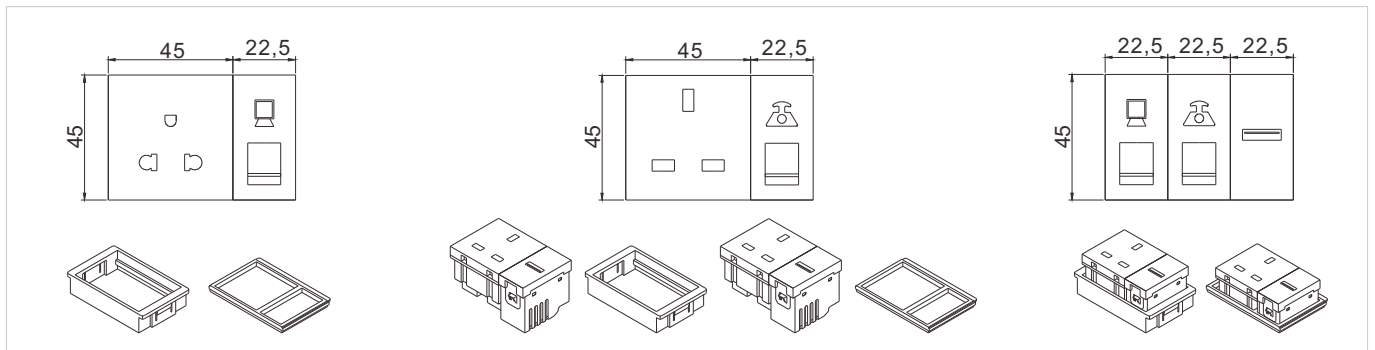

4 way

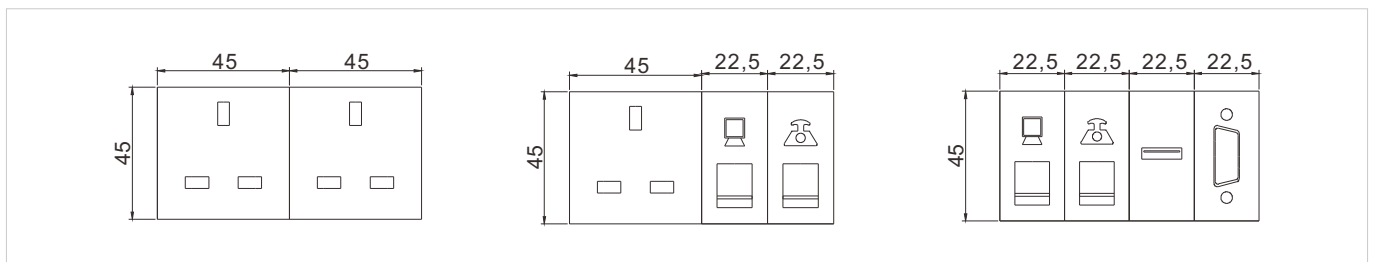

Desktop Socket

Floor Socket

Accessories

Switch

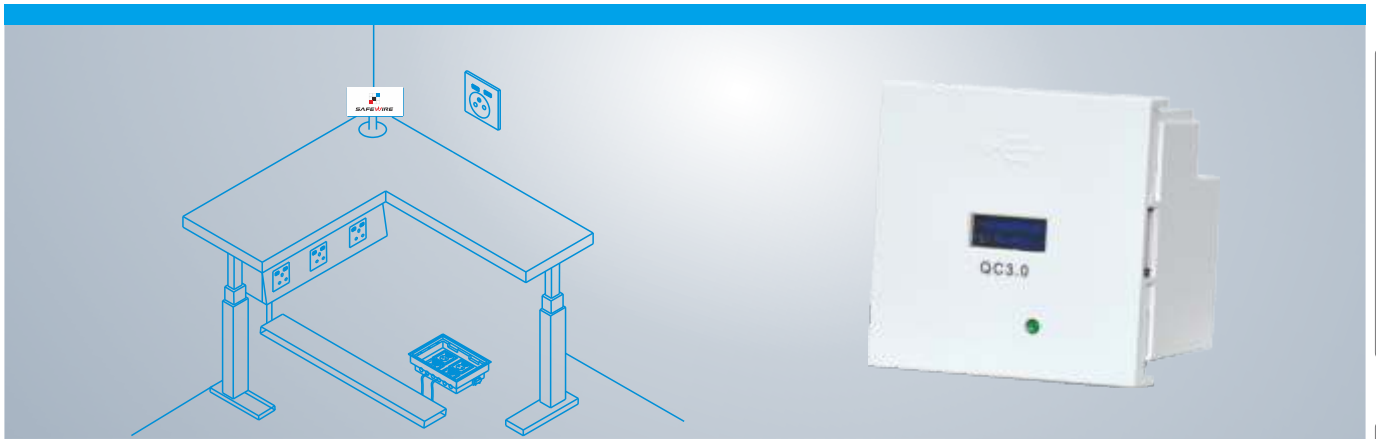

Desktop Socket

Floor Socket

Accessories

Switch

XJY-USB-17J USB Charger Series

Features:

1. Voltage withstanding: above 3KV.
2. Lightning protection level: 3K.
3. With identifying chip: can automatically recognize different mobiles and suit its request charging AMP to meet the charging speed.
4. Energy saving: Reach European power consuming Level 6.
5. With overload L current and over voltage protection.
6. Output ripple VPP <200mV. (connected phone response is fast while the phone while charging).
7. Automatically cut off after fully charged and not continue to charge the phone.
8. More life reliability: over 5 years.

Outline Drawing: Unit:mm

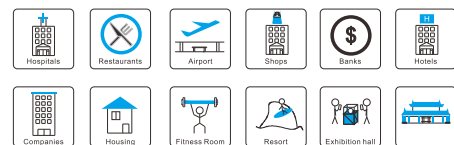
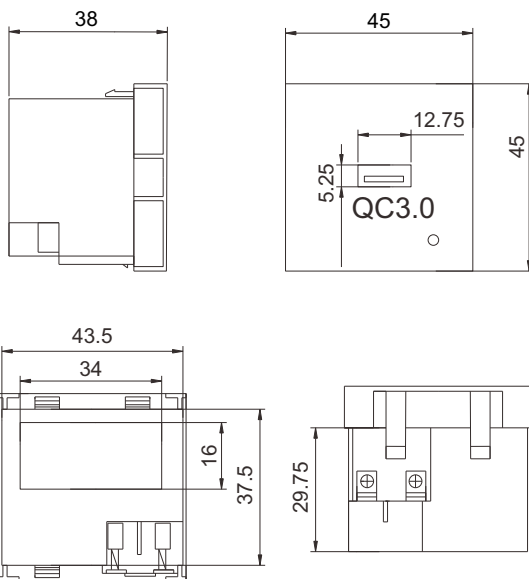

Desktop Socket

Floor Socket

Accessories

Switch

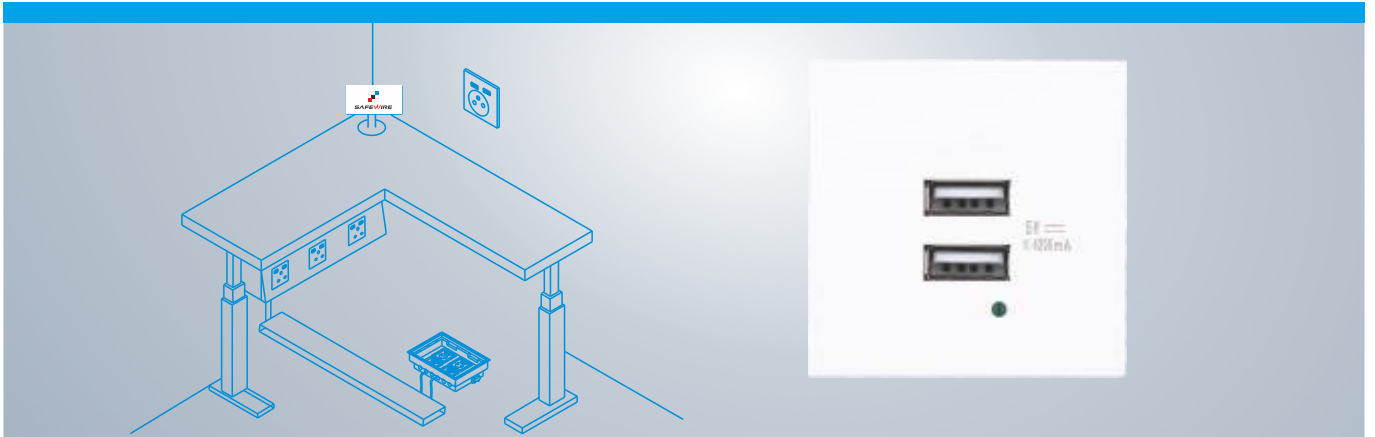

XJY-USB-17E USB Charger Series

Features:

1. Voltage withstanding: above 3KV.
2. Lightning protection level: 3K.
3. With identifying chip: can automatically recognize different mobiles and suit its request charging AMP to meet the charging speed.
4. Energy saving: Reach European power consuming Level 6.
5. With overload L current and over voltage protection.
6. output ripple VPP <200mV. (connected phone response is fast while the phone while charging).
7. Automatically cut off after fully charged and not continue to charge the phone.
8. More life reliability: over 5 years.

Outline Drawing: Unit:mm

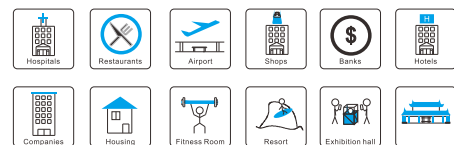
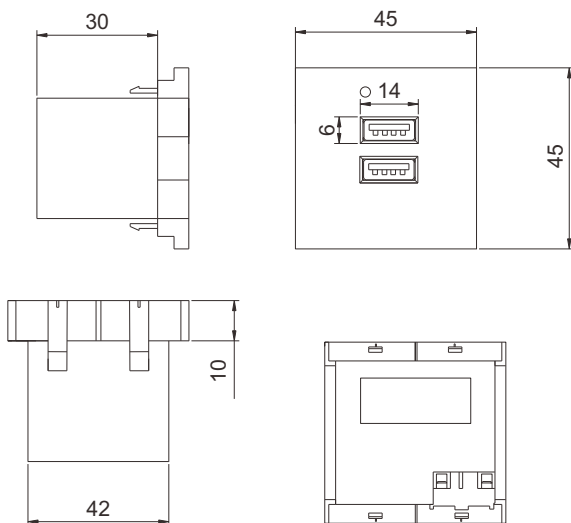



Desktop Socket

Floor Socket

Accessories

Switch

XJY-USB-18B USB Charger Series

Features:

1. Dual charge USB charging port: can be supplied for both 2 sets of equipment at high speed. Power supplies stable and the can be use of various types of global USB charging equipment.
2. Current stabilizing protective electric appliance.
3. Compatible with multiple models of apple, Android and other devices.
4. Automatic distribution current, over charge protection, short circuit protection.
5. MAX 5V dual 2.1A USB output power, charges really fast.

Outline Drawing: Unit:mm

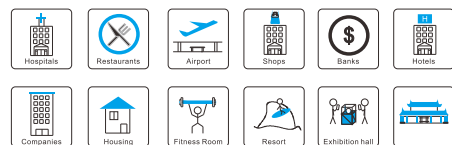
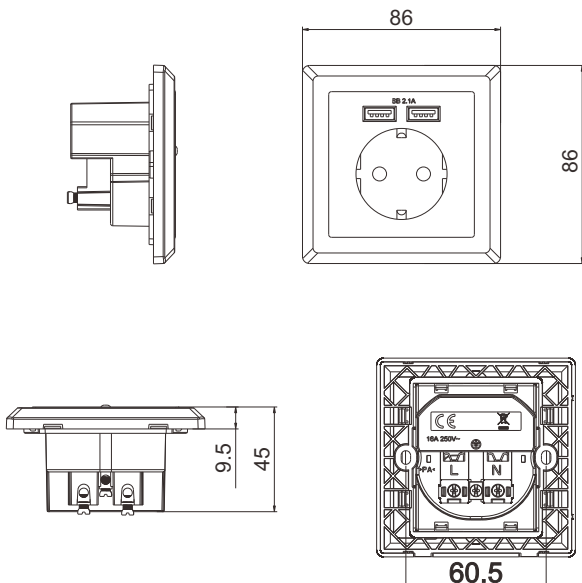

Desktop Socket

Floor Socket

Accessories

Switch

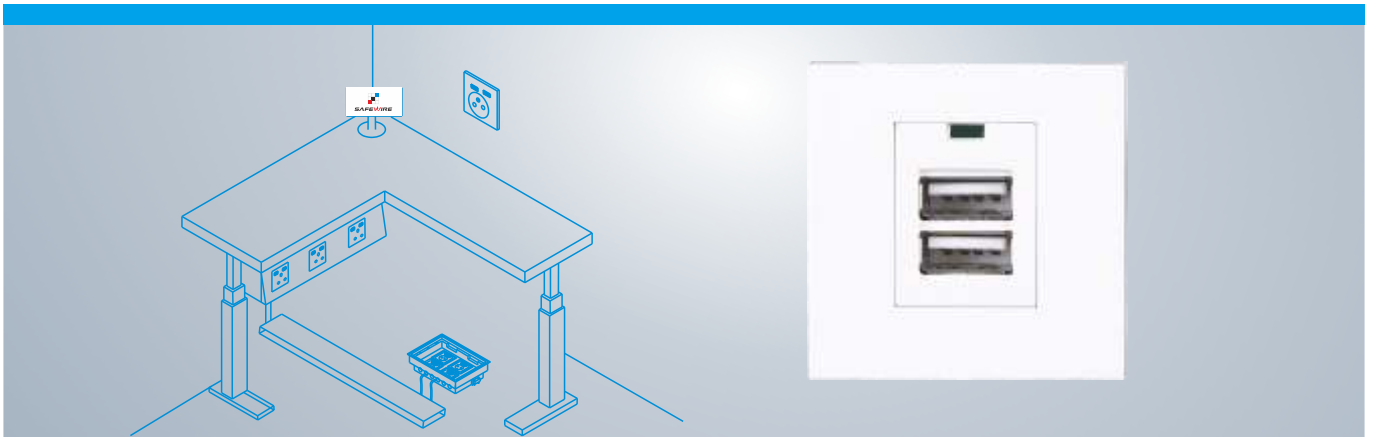

XJY-USB-26-A/A USB Charger Series







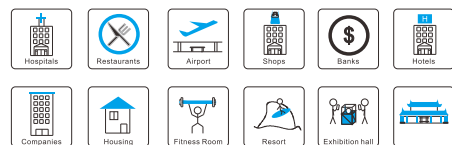
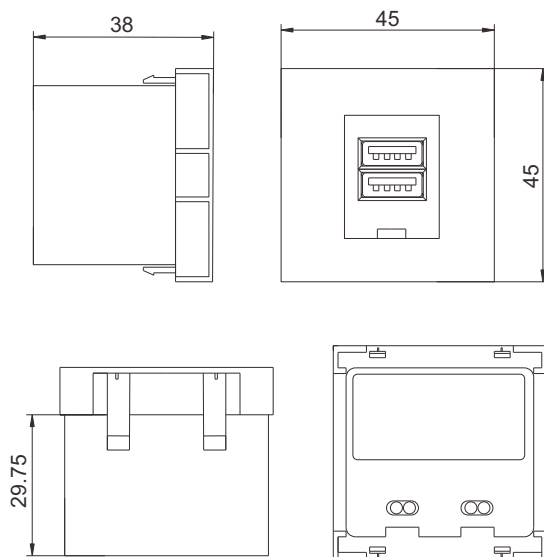





Features:

1. Voltage withstanding: above 3KV.
2. Lightning protection level: 3K.
3. With identifying chip: can automatically recognize different mobiles and suit its request charging AMP to meet the charging speed.
4. Energy saving: Reach European power consuming Level 6;
5. With overload L current and over voltage protection.
6. output ripple VPP <200mV. (connected phone response is fast while the phone while charging).
7. Automatically cut off after fully charged and not continue to charge the phone.
8. More life reliability: over 5 years.

Outline Drawing: Unit:mm

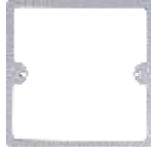















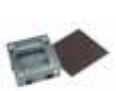

Bridge accessories for floor box

					
SAP028	SAP026	SAP024	SAP027	SAP025	SAP030
					
SAP031	SAP032	SADF01	SAP01	SAP02	SAP03

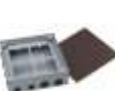
Desktop Socket

Sink Box

Item									
	LH-100-38	HTD-120JH	HTD-200JH	HTD-100JH	HTD-122JH	HTD-122LH	HTD-160LH-50F	HTD-110JH	HTD-135JH
Dimension	100X100X38mm	120X120X60mm	100X200X55mm	100X100X55mm	122X122X58mm	122X122X60mm	160X160X60mm	110X110X75mm	135X135X75mm
Item									
	HTD-170JH	HTD-170JHA	HTD-190JH	HTD-190JHA	HTD-230JH	HTD-230JHA	HTD-290JH	HTD-190CJH	HTD-240CJH
Dimension	170X170X75mm	170X170X90mm	190X190X75mm	190X190X90mm	230X230X75mm	230X230X90mm	290X140X75mm	190X190X75mm	240X170X75mm

Floor Socket

Accessories

Optical fiber patch cord/cable (FC-FC,FC-SC,SC-SC,ST-ST.....)& Accessories.

								
RJ45 Patch Cord In Yellow Color	RJ45 Patch Cord In Gray Color	RJ45 Patch Cord In Blue Color	RJ45 Patch Cord In Green Color	SC-SC Single-mode Patch Cord	SC-SC Multi-mode Patch Cord	ST-ST Single-mode Patch Cord	FC-SC Single-mode Patch Cord	LC-LC Single-mode Patch Cord

Switch

Faceplate of internet data

			
single face plate	dual-port face plate	3-port face plate	4-port face plate