



Electrical Wiring & Cable Management
—Plug and play!



Floor socket/Table socket/Wiring accessories



2018 Year Safewire Catalogue

Wenzhou Safewire Electric Co.,Ltd.



About Us



Wenzhou Safewire Electric Co.,Ltd is a company specialized in the manufacture and sale of items in the field of electrical installation material and goods. The Safewire behind the flag ship brand Feilifu ,Feilifu Technology Co., Ltd was established on 1998. Since then, we embarked on the relentless pursuit of being the biggest supplier with over 30,000 square meters building areas in China as we choose only the best and safest electrical products with their consumers in mind.

Safewire is engaged in producing and selling high-quality wiring systems produced in accordance with international standards. Our factory was recognized through ISO9001, ISO14001,OHSAS18001. And also be 3rd quality certification such as CE and SASO etc.

After 20 years of continuous improvement and innovation, we obtained over 80 patents related to floor sockets and electrical sockets. A favourite with architects and building specifiers, Safewire electric sockets are suited to domestic or commercial applications such as shopping centres, airports, conference halls, hotels, railway stations, health centres, sports centres, museums, terraces, gardens and kitchens. Today, we have a line over 100 products. Everyone of them was developed through extensive R&D and customer feedback.

We provided OEM and ODM service for most worldwide brands. And exported products& service to over 56 countries in Europ, Australia, Middle East and Southeast etc. When our clients purchase our products, they know they are getting value for their money, with performance, reliability and quality. Every product carries our personal guarantee and service commitment. Our team stands behind every product we sell-even years after it is installed. We now offer reliable years warranty on all Safewire products, covering parts and labor. We have buit our reputation on this.

Of course we also have a huge range of shapes, sizes, boxes with IP Ratings and your choice of a metal finish or inlay, all readily available from your local electrical wholesaler. If none of our options are suitable for your application, please contact us about customization solution for you.

The world will keep changing. This is what keeps Safewire ahead. Listening to, and acting on, customer feedback sets our products apart from others. Safewire, On the way!



Quality system Certificates
14001,18001 Certificates



CCC Quality Certificates



Patent Certificates



CE Certificates
SASO Certificates

Fine Workmanship Make Competitive Floor Socket

From material selection to finished product, we focus on every detail of multi-process, layers of management and control, seeking increasing perfection...



Products are tested one by one, and not let a non-conforming product into the market.



POP-UP TYPE FLOOR SOCKET

Floor socket / Table socket / Waterproof socket

Terminal for Floor Socket



Terminal block code: HTJ-001
Fast connection terminal

- Hard wire insert connected;
- Suit wire 1mm²-2.5mm².

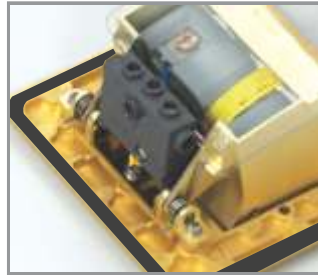

Terminal block code: HTJ-002
3 screws terminal

- Tight by screw;
- Suit wire 0.5mm²-6mm²;
- Suit hard wire & soft wire.

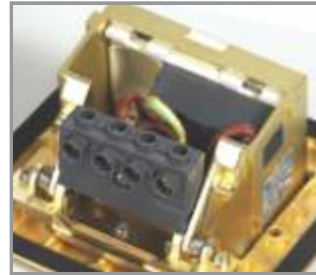

Terminal block code: HTJ-003
4 screw terminal

- Tight by screw;
- Suit wire 0.5mm²-6mm²;
- Suit hard wire & soft wire;
- More terminal connected, suit for three phase 4 wire.



Wire clamp: HTJ-003

- Hold the wire more tight.

Soft Type (Adjustable) Floor Socket

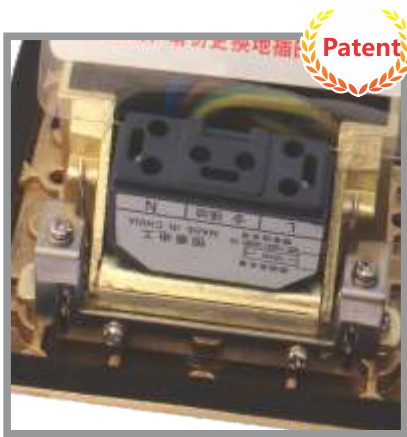

HTD-ZN-16, HTD-ZN-18



Soft Pop-up
Code:ZN



Pop-up
Slowly



More safety

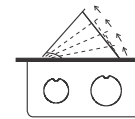

10 Times

The floor socket equipped with soft starting device, the opening speed of which is 20 times slower than regular products. State for opening: uniform speed, slow.

This series product has won national invention patent and new type practical patent. Compared with all kinds of present Pop - up floor socket, it has the characteristics of long life, stable performance, little noise and safe to operate etc. Lightly dial the lock catch, the Pop - up mechanism will rising slowly at even speed and the nearby electrical equipments can easily get power from the product, which thoroughly solve the defects of short life, big noise, unsafe, etc. that caused by big impulse force the present similar products brought when Pop - up. It is also easy for installation.

The Fig takes HTD-16 Soft Pop - up type floor socket as an example.

No additional instructions for other products as the schematic diagrams are similar to the product.

E.g.: HTD-4/4L, HTD-7/7L, HTD-3T/3P, HTD-2T/2P, HTD-20, HTD-16/16L, HTD-18/18L, HTD-26/26L, HTD-28/28L, HTD-402/402L, HTD-1602/1602L

Floor socket codes and meanings

HTD - 146CNKP / 2F3-F4F5

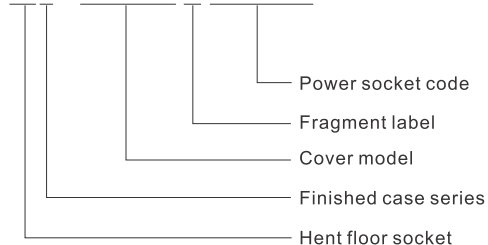

Material code

T	Brass
L	Al.Alloy
P	Stainless steel
S	Plastic

Function code

K	Open cover type
LX	Swivel type
LS	Screw fixing type
ZN	Soft start type
NK	Horizontal open type
X	Waterproof

Function code

FS	Water proof outlet
HK	Double cable outlet
DK	Single cable outlet
CK	Single cable outlet
A	Side insert structure
E	Flush edge

TYPICAL PROJECT



POP-UP TYPE FLOOR SOCKET

FINE WORKMANSHIP MAKE
Competitive Floor Socket





POP-UP Type Floor Socket

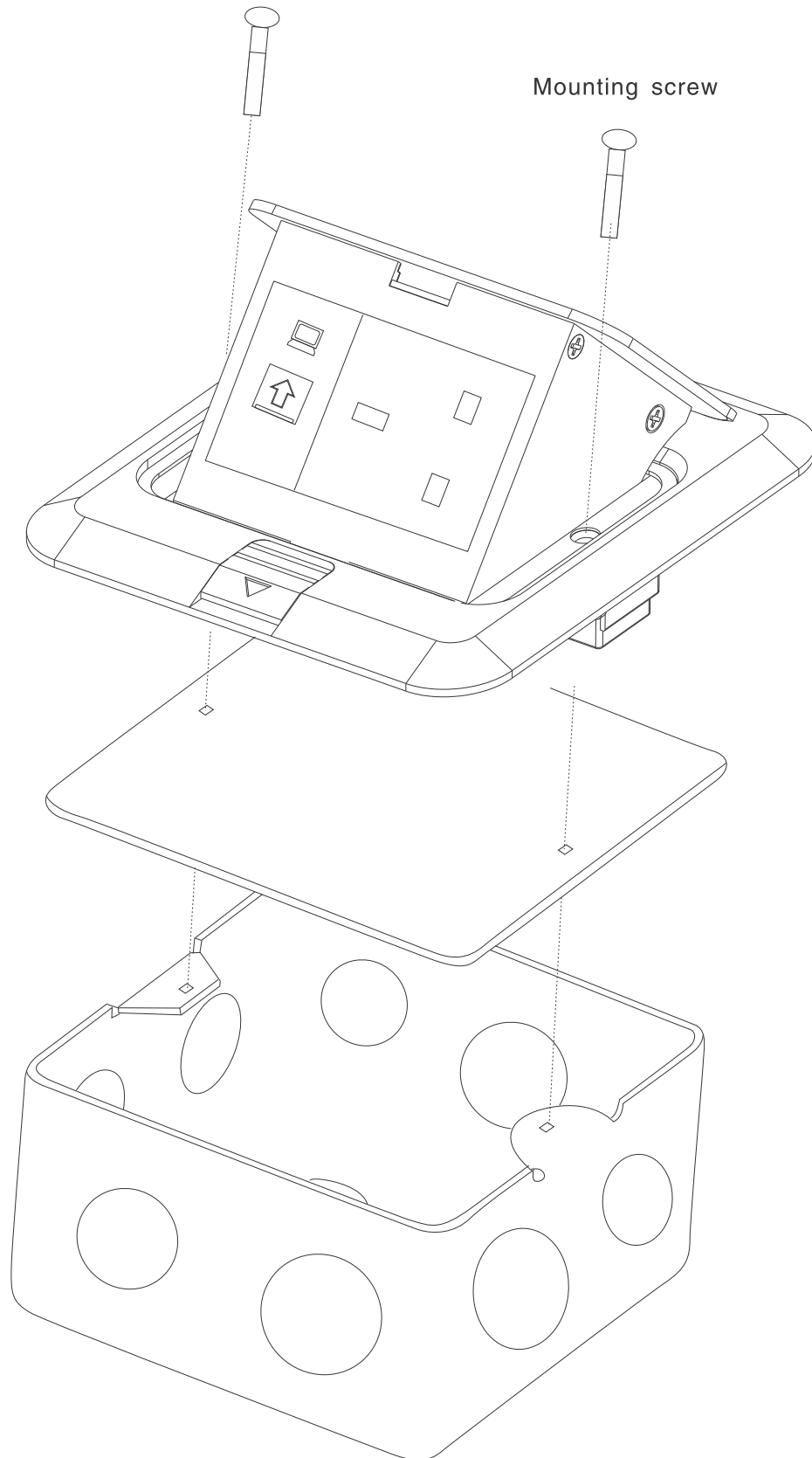

WATERPROOF TYPE FLOOR SOCKET

Floor socket / Table socket / Waterproof socket



HTD-17X
Cu-alloy



HTD-17XL
Alu-alloy



Waterproof box

HTD-17X Floor Boxes Series

Basic Parameter:

Panel Dimension:	120×120mm
Panel Material:	Brass alloy & Alu alloy
Finishing:	Wire drawing/Polishing / Spray painting
Interface size:	3 Modules
Bracket Material:	Zinc Alloy & Alu Alloy
Basebox material:	Steel+Zinc plated

▲For special requirements & OEM/ODM service, please consult us.

Product specifications:

Part Number	Panel Material	Open style
HTD-17X	Brass Alloy(62%Cu)	Normal Pop-up
HTD-17XL	Alu- Alloy(85%Al)	Normal Pop-up
HTD-ZN-17X	Brass Alloy(62%Cu)	Soft Pop-up
HTD-ZN-17XL	Alu- Alloy(85%Al)	Soft Pop-up

Available sockets :

45 Type

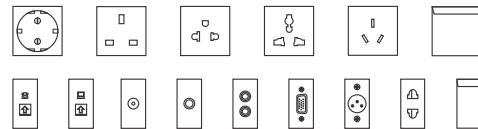

118 Type



◇Please check all kinds of sockets refer to page 45-46.

Outline Drawing:

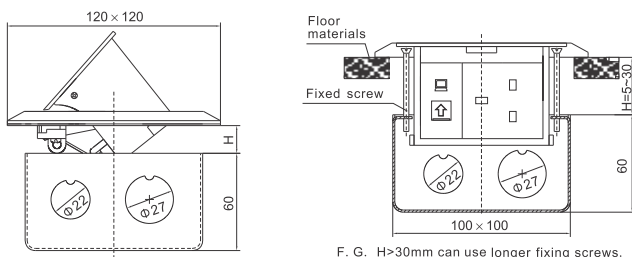

▲Temporary lid
Secure to box body during concrete pour
to prevent ingress of slurry.

▲Base box
Ga-Steel box body:100x100x60mm

WATERPROOF TYPE FLOOR SOCKET

Floor socket / Table socket / Waterproof socket



HTD-41X
Cu-alloy



HTD-41XL
Alu-alloy



Waterproof box

HTD-41X Floor Boxes Series

Basic Parameter:

Panel Dimension:	120×120mm
Panel Material:	Brass alloy & Stainless-Steel
Finishing:	Wire drawing/Polishing / Spray painting
Interface size:	3 Modules
Bracket Material:	Zinc Alloy & Alu Alloy
Basebox material:	Steel+Zinc plated

▲For special requirements & OEM/ODM service, please consult us.

Part specifications:

Part Number	Panel Material	Open style
HTD-41X	Brass Alloy(62%Cu)	Normal Pop-up
HTD-41XL	Alu- Alloy(85%Al)	Normal Pop-up
HTD-ZN-41X	Brass Alloy(62%Cu)	Soft Pop-up
HTD-ZN-41XL	Alu- Alloy(85%Al)	Soft Pop-up

Available sockets :

45 Type

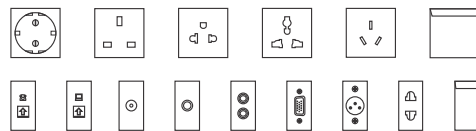

118 Type



◁Please check all kinds of sockets refer to page 45-46.

Outline Drawing:

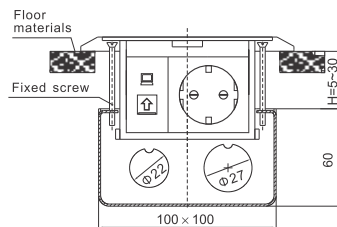
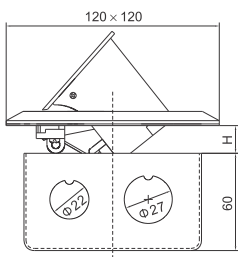

F. G. H>30mm can use longer fixing screws.



▲Temporary lid
Secure to box body during concrete pour
to prevent ingress of slurry.

▲Base box
Ga-Steel box body:100x100x60mm



POP-UP TYPE FLOOR SOCKET

Floor socket / Table socket / Waterproof socket



HTD-4
Cu-alloy



HTD-4L
Alu-alloy



HTD-4 Floor Boxes Series

Basic Parameter:

Panel Dimension:	120×120mm
Panel Material:	Brass alloy & Alu alloy
Finishing:	Wire drawing/Polishing / Spray painting
Interface size:	3 Modules
Bracket Material:	Zinc Alloy & Alu Alloy
Basebox material:	Steel+Zinc plated

▲For special requirements & OEM/ODM service, please consult us.

Product specifications:

Part Number	Panel Material	Open style
HTD-4	Brass Alloy(62%Cu)	Normal Pop-up
HTD-4L	Alu- Alloy(85%Al)	Normal Pop-up
HTD-ZN-4	Brass Alloy(62%Cu)	Soft Pop-up
HTD-ZN-4L	Alu- Alloy(85%Al)	Soft Pop-up

Available sockets :

45 Type

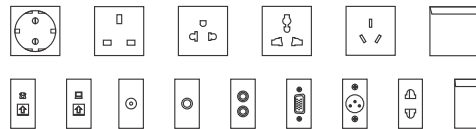

118 Type



◇Please check all kinds of sockets refer to page 45-46.

Outline Drawing:

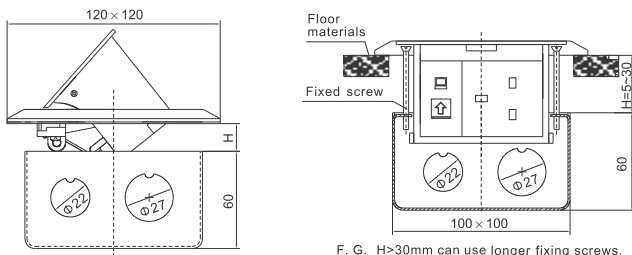

▲Temporary lid
Secure to box body during concrete pour
to prevent ingress of slurry.

▲Base box
Ga-Steel box body:100x100x60mm

POP-UP TYPE FLOOR SOCKET

Floor socket / Table socket / Waterproof socket



HTD-2
Cu-alloy



HTD-2P
SUS



HTD-2 Floor Boxes Series

Basic Parameter:

Panel Dimension:	120×120mm
Panel Material:	Brass alloy & Stainless-Steel
Finishing:	Wire drawing/Polishing / Spray painting
Interface size:	3 Modules
Bracket Material:	Zinc Alloy & Alu Alloy
Basebox material:	Steel+Zinc plated

▲For special requirements & OEM/ODM service, please consult us.

Part specifications:

Part Number	Panel Material	Open style
HTD-2	Brass Alloy(62%Cu)	Normal Pop-up
HTD-2P	Stainless-Steel	Normal Pop-up
HTD-ZN-2	Brass Alloy(62%Cu)	Soft Pop-up
HTD-ZN-2P	Stainless-Steel	Soft Pop-up

Available sockets :

45 Type

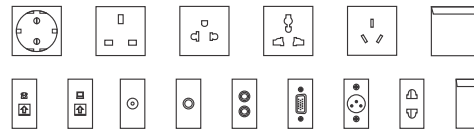

118 Type



◊Please check all kinds of sockets refer to page 45-46.

Outline Drawing:

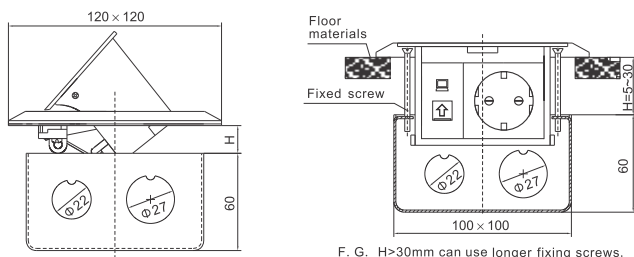

▲Temporary lid
Secure to box body during concrete pour
to prevent ingress of slurry.

▲Base box
Ga-Steel box body:100x100x60mm

POP-UP TYPE FLOOR SOCKET

Floor socket / Table socket / Waterproof socket



HTD-3
Cu-alloy



HTD-3P
SUS



HTD-3 Floor Boxes Series

Basic Parameter:

Panel Dimension:	Φ150mm
Panel Material:	Brass alloy & Stainless-Steel
Finishing:	Wire drawing/Polishing / Spray painting
Interface size:	3 Modules
Bracket Material:	Zinc Alloy & Alu Alloy
Basebox material:	Steel+Zinc plated

▲For special requirements & OEM/ODM service, please consult us.

Product specifications:

Part Number	Panel Material	Open style
HTD-3	Brass Alloy(62%Cu)	Normal Pop-up
HTD-3P	Stainless- Steel	Normal Pop-up
HTD-ZN-3	Brass Alloy(62%Cu)	Soft Pop-up
HTD-ZN-3P	Stainless- Steel	Soft Pop-up

Available sockets :

45 Type

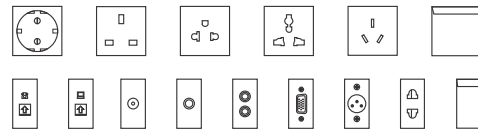

118 Type



◇Please check all kinds of sockets refer to page 45-46.

Outline Drawing:

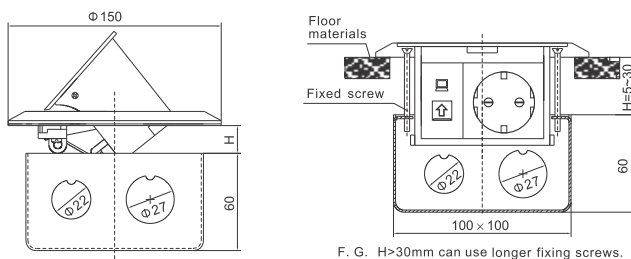

▲Temporary lid
Secure to box body during concrete pour
to prevent ingress of slurry.

▲Base box
Ga-Steel box body:100x100x60mm



POP-UP TYPE FLOOR SOCKET

Floor socket / Table socket / Waterproof socket



HTD-7
Cu-alloy



HTD-7L
Alu alloy



HTD-7 Floor Boxes Series

Basic Parameter:

Panel Dimension:	Φ150mm
Panel Material:	Brass alloy & Alu alloy
Finishing:	Wire drawing/Polishing / Spray painting
Interface size:	3 Modules
Bracket Material:	Zinc Alloy & Alu Alloy
Basebox material:	Steel+Zinc plated

▲For special requirements & OEM/ODM service, please consult us.

Part specifications:

Part Number	Panel Material	Open style
HTD-7	Brass Alloy(62%Cu)	Normal Pop-up
HTD-7L	Alu- Alloy(85%Al)	Normal Pop-up
HTD-ZN-7	Brass Alloy(62%Cu)	Soft Pop-up
HTD-ZN-7L	Alu- Alloy(85%Al)	Soft Pop-up

Available sockets :

45 Type

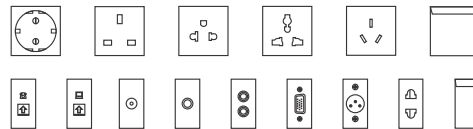

118 Type



◁Please check all kinds of sockets refer to page 45-46.

Outline Drawing:

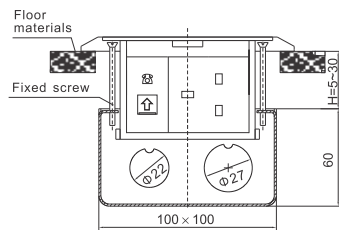
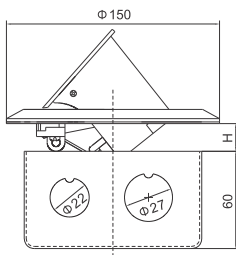

▲Temporary lid
Secure to box body during concrete pour
to prevent ingress of slurry.

▲Base box
Ga-Steel box body:100x100x60mm

POP-UP TYPE FLOOR SOCKET

Floor socket / Table socket / Waterproof socket



HTD-16
Cu-alloy



HTD-16L
Alu-alloy



HTD-16 Floor Boxes Series

Basic Parameter:

Panel Dimension:	120×120mm
Panel Material:	Brass alloy & Alu-alloy
Finishing:	Wire drawing/Polishing / Spray painting
Interface size:	3 Modules
Bracket Material:	Zinc Alloy & Alu Alloy
Basebox material:	Steel+Zinc plated

▲For special requirements & OEM/ODM service, please consult us.

Product specifications:

Part Number	Panel Material	Open style
HTD-16	Brass Alloy(62%Cu)	Normal Pop-up
HTD-16L	Alu- Alloy(85%Al)	Normal Pop-up
HTD-ZN-16	Brass Alloy(62%Cu)	Soft Pop-up
HTD-ZN-16L	Alu- Alloy(85%Al)	Soft Pop-up

Available sockets :

45 Type

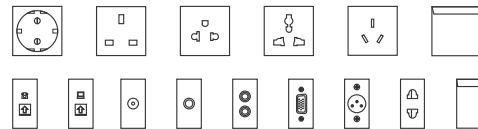

118 Type



◇Please check all kinds of sockets refer to page 45-46.

Outline Drawing:

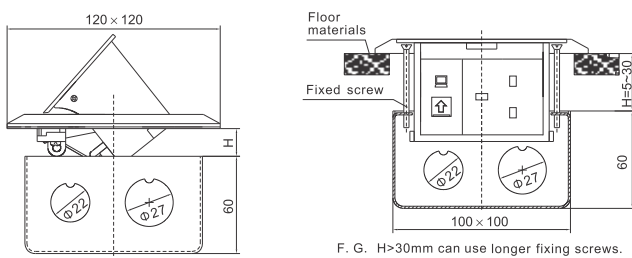

▲Temporary lid
Secure to box body during concrete pour
to prevent ingress of slurry.

▲Base box
Ga-Steel box body:100x100x60mm

POP-UP TYPE FLOOR SOCKET

Floor socket / Table socket / Waterproof socket



HTD-26
Cu-alloy



HTD-26L
Alu alloy



HTD-26 Floor Boxes Series

Basic Parameter:

Panel Dimension:	146×146mm
Panel Material:	Brass alloy & Alu alloy
Finishing:	Wire drawing/Polishing / Spray painting
Interface size:	4 Modules
Bracket Material:	Zinc Alloy & Alu Alloy
Basebox material:	Steel+Zinc plated

▲For special requirements & OEM/ODM service, please consult us.

Part specifications:

Part Number	Panel Material	Open style
HTD-26	Brass Alloy(62%Cu)	Normal Pop-up
HTD-26L	Alu- Alloy(85%Al)	Normal Pop-up
HTD-ZN-26	Brass Alloy(62%Cu)	Soft Pop-up
HTD-ZN-26L	Alu- Alloy(85%Al)	Soft Pop-up

Available sockets :

45 Type

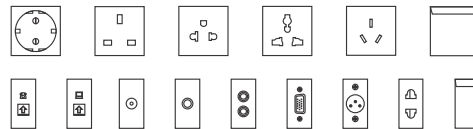

◊Please check all kinds of sockets refer to page 45-46.

Outline Drawing:

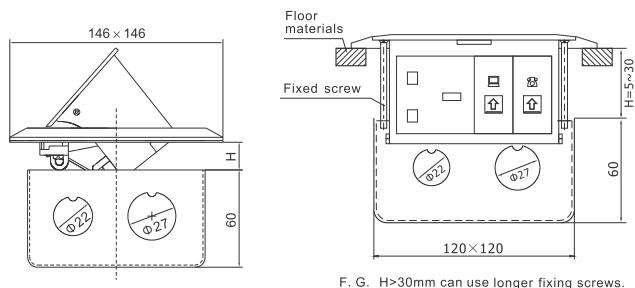

F. G. H>30mm can use longer fixing screws.



▲Temporary lid
Secure to box body during concrete pour
to prevent ingress of slurry.

▲Base box
Ga-Steel box body:120x120x60mm

POP-UP TYPE FLOOR SOCKET

Floor socket / Table socket / Waterproof socket



HTD-18
Cu-alloy



HTD-18L
Alu alloy



HTD-18 Floor Boxes Series

Basic Parameter:

Panel Dimension:	128×120mm
Panel Material:	Brass alloy & Alu alloy
Finishing:	Wire drawing/Polishing / Spray painting
Interface size:	3 Modules
Bracket Material:	Zinc Alloy & Alu Alloy
Basebox material:	Steel+Zinc plated

▲For special requirements & OEM/ODM service, please consult us.

Part specifications:

Part Number	Panel Material	Open style
HTD-26	Brass Alloy(62%Cu)	Normal Pop-up
HTD-26L	Alu- Alloy(85%Al)	Normal Pop-up
HTD-ZN-26	Brass Alloy(62%Cu)	Soft Pop-up
HTD-ZN-26L	Alu- Alloy(85%Al)	Soft Pop-up

Available sockets :

45 Type

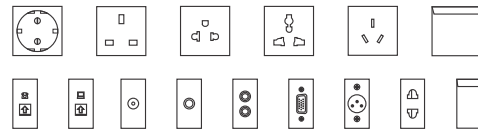

118 Type



◇Please check all kinds of sockets refer to page 45-46.

Outline Drawing:

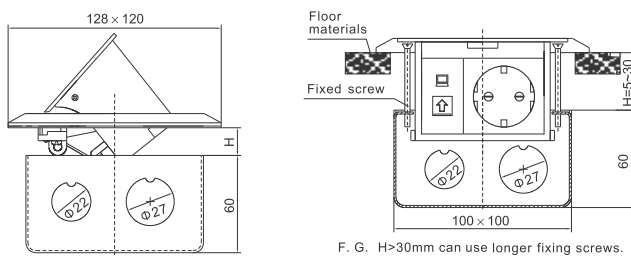

▲Temporary lid
Secure to box body during concrete pour
to prevent ingress of slurry.

▲Base box
Ga-Steel box body:100x100x60mm

POP-UP TYPE FLOOR SOCKET

Floor socket / Table socket / Waterproof socket



HTD-28
Cu-alloy



HTD-28L
Alu-alloy



HTD-28 Floor Boxes Series

Basic Parameter:

Panel Dimension:	154×146mm
Panel Material:	Brass alloy & Alu-alloy
Finishing:	Wire drawing/Polishing / Spray painting
Interface size:	4 Modules
Bracket Material:	Zinc Alloy & Alu Alloy
Basebox material:	Steel+Zinc plated

▲For special requirements & OEM/ODM service, please consult us.

Product specifications:

Part Number	Panel Material	Open style
HTD-28	Brass Alloy(62%Cu)	Normal Pop-up
HTD-28L	Alu- Alloy(85%Al)	Normal Pop-up
HTD-ZN-28	Brass Alloy(62%Cu)	Soft Pop-up
HTD-ZN-28L	Alu- Alloy(85%Al)	Soft Pop-up

Available sockets :

45 Type

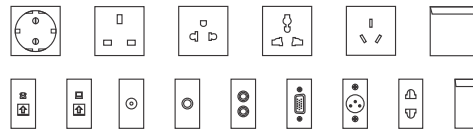

◊Please check all kinds of sockets refer to page 45-46.

Outline Drawing:

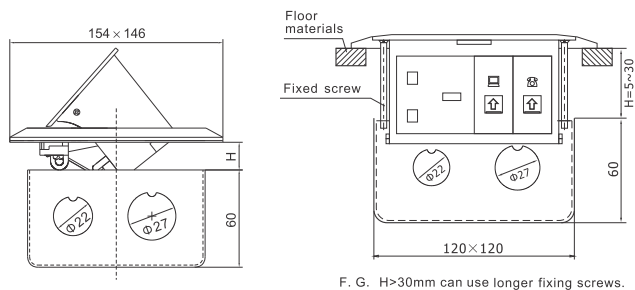

▲Temporary lid
Secure to box body during concrete pour to prevent ingress of slurry.

▲Base box
Ga-Steel box body:120x120x60mm

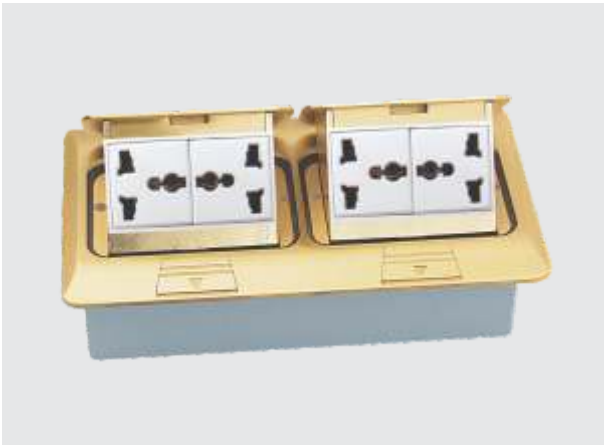

HTD-1602
Cu-alloy



HTD-1602L
Alu alloy

HTD-1602 Floor Boxes Series

Basic Parameter:

Panel Dimension:	220×120mm
Panel Material:	Brass alloy & Alu alloy
Finishing:	Wire drawing/Polishing / Spray painting
Interface size:	6 Modules
Bracket Material:	Zinc Alloy & Alu Alloy
Basebox material:	Steel+Zinc plated

▲For special requirements & OEM/ODM service, please consult us.

Part specifications:

Part Number	Panel Material	Open style
HTD-1602	Brass Alloy(62%Cu)	Normal Pop-up
HTD-1602L	Alu- Alloy(85%Al)	Normal Pop-up
HTD-ZN-1602	Brass Alloy(62%Cu)	Soft Pop-up
HTD-ZN-1602L	Alu- Alloy(85%Al)	Soft Pop-up

Available sockets :

45 Type

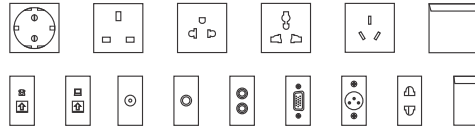

118 Type



◇Please check all kinds of sockets refer to page 45-46.

Outline Drawing:

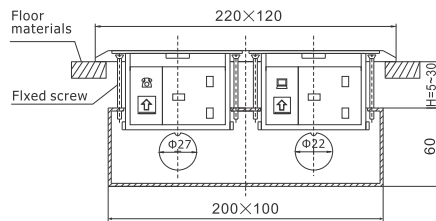
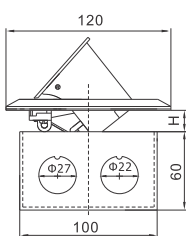

F. G. H>30mm can use longer fixing screws.



▲ Temporary lid
Secure to box body during concrete pour
to prevent ingress of slurry.

▲ Base box
Ga-Steel box body:200x100x60mm



HTD-402 Floor Boxes Series

Basic Parameter:

Panel Dimension:	220×120mm
Panel Material:	Brass alloy & Alu-alloy
Finishing:	Wire drawing/Polishing / Spray painting
Interface size:	6 Modules
Bracket Material:	Zinc Alloy & Alu Alloy
Basebox material:	Steel+Zinc plated

▲For special requirements & OEM/ODM service, please consult us.



Product specifications:

Part Number	Panel Material	Open style
HTD-402	Brass Alloy(62%Cu)	Normal Pop-up
HTD-402L	Alu- Alloy(85%Al)	Normal Pop-up
HTD-ZN-402	Brass Alloy(62%Cu)	Soft Pop-up
HTD-ZN-402L	Alu- Alloy(85%Al)	Soft Pop-up

Available sockets :

45 Type

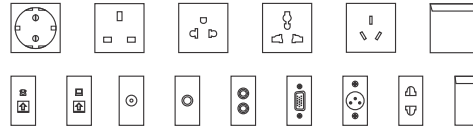

118 Type



◊Please check all kinds of sockets refer to page 45-46.



HTD-402
Cu-alloy



HTD-402L
Alu-alloy

Outline Drawing:

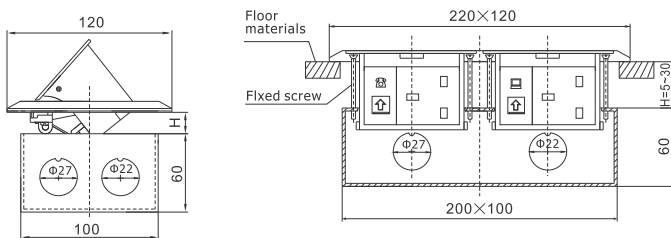

F. G. H>30mm can use longer fixing screws.



- ▲ Temporary lid
Secure to box body during concrete pour to prevent ingress of slurry.
- ▲ Base box
Ga-Steel box body:200x100x60mm



POP-UP TYPE FLOOR SOCKET

Floor socket / Table socket / Waterproof socket



HTD-8
Cu-alloy



HTD-8P
SUS



HTD-8 Floor Boxes Series

Basic Parameter:

Panel Dimension:	125×125mm
Panel Material:	Brass alloy & Stainless-Steel
Finishing:	Wire drawing/Polishing / Spray painting
Interface size:	6 Modules
Bracket Material:	Zinc Alloy & Alu Alloy
Basebox material:	Steel+Zinc plated

▲For special requirements & OEM/ODM service, please consult us.

Product specifications:

Part Number	Panel Material	Open style
HTD-8	Brass Alloy(62%Cu)	Normal Pop-up
HTD-8P	Stainless- Steel	Normal Pop-up

Available sockets :

45 Type

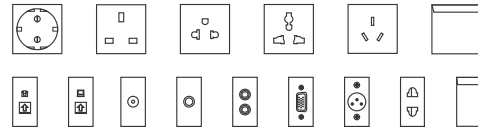

118 Type



◇Please check all kinds of sockets refer to page 45-46.

Outline Drawing:

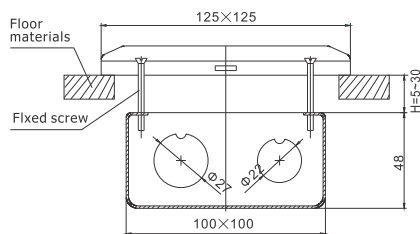

F. G. H>30mm can use longer fixing screws.



▲Temporary lid
Secure to box body during concrete pour to prevent ingress of slurry.

▲Base box
Ga-Steel box body:100x100x48mm



POP-UP TYPE FLOOR SOCKET

Floor socket / Table socket / Waterproof socket



HTD-10
Cu-alloy



HTD-10P
SUS

HTD-10 Floor Boxes Series

Basic Parameter:

Panel Dimension:	125×75mm
Panel Material:	Brass alloy & Stainless-Steel
Finishing:	Wire drawing/Polishing / Spray painting
Interface size:	3 Modules
Bracket Material:	Zinc Alloy & Alu Alloy
Basebox material:	Steel+Zinc plated

▲For special requirements & OEM/ODM service, please consult us.

Product specifications:

Part Number	Panel Material	Open style
HTD-10	Brass Alloy(62%Cu)	Normal Pop-up
HTD-10P	Stainless- Steel	Normal Pop-up

Available sockets :

45 Type

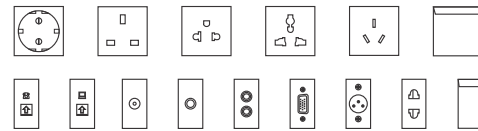

118 Type



◊Please check all kinds of sockets refer to page 45-46.

Outline Drawing:

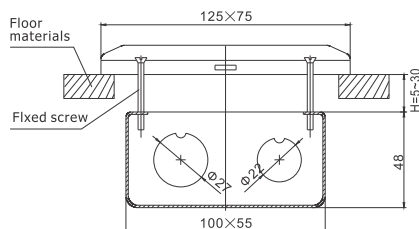

F. G. H>30mm can use longer fixing screws.



▲Temporary lid
Secure to box body during concrete pour
to prevent ingress of slurry.

▲Base box
Ga-Steel box body:100x55x48mm

OPEN COVER TYPE FLOOR SOCKET
FINE WORKMANSHIP MAKE
Competitive Floor Socket



OPEN COVER TYPE FLOOR SOCKET

Floor socket / Table socket / Waterproof socket



OPEN COVER TYPE (FLAT OPEN) floor socket



Flat open
Code: NK



Panel and cover
keep parallel



More safety



Material: Brass



Material:
Stainless steel

Improvement instruction

Novel design for panel, the top cover keeps parallel with floor (180°) when opening. Can be used for special plug socket or more plugs at the same time. It can avoid fallback of cover when taking power (information), which improves the security for product during using.



HTD-120NKT
120×120mm



HTD-3402NKT
180×340mm



HTD-2702NK
146×270mm

The Fig takes HTD-180 open cover type floor socket as an example. No additional instructions for other products as the schematic diagrams are similar to the product.

This series product is used for open cover type floor socket

HTD-120, HTD-140, HTD-146, HTD-180,
HTD-210, HTD-250, HTD-2242, HTD-2702,
HTD-3402, HTD-300

CABLE EXIT PROTECTIVE PORT

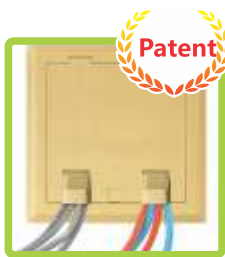

DK cable outlet fixing



HK cable outlet fixing

This outlet port is used for open cover type floor socket



Material: Brass



Material:
Stainless steel



Beautiful and simple design
for outlet port



Improvement instruction



DK cable exit
Code: DK

Outlet protective port

With outlet hole of big caliber, when not taking power (information), the outlet port (face) keeps flat with the plane of floor socket. During using, the outlet port (reverse) can lead multi-strand wire cable out of the floor socket and effectively protect the wire cable skin against damaging.



HK cable exit
Code: DK

HK Cable exit

No additional instructions for other products as the schematic diagrams are



Open Cover Type Floor Socket





OPEN COVER TYPE FLOOR SOCKET

Floor socket / Table socket / Waterproof socket



HTD-11
Cu-alloy



HTD-11P
SUS



HTD-12
Cu-alloy



HTD-12P
SUS

HTD-11/12 Floor Boxes Series

Basic Parameter:

Panel Dimension:	11(120×120mm);12(Φ135mm)
Panel Material:	Brass alloy & Stainless-Steel
Finishing:	Wire drawing/Polishing / Spray painting
Interface size:	3 Modules
Bracket Material:	Zinc Alloy & Alu Alloy
Basebox material:	Steel+Zinc plated

▲For special requirements & OEM/ODM service, please consult us.

Product specifications:

Part Number	Panel Material	Open style
HTD-11	Brass Alloy(62%Cu)	Open and hidden
HTD-11P	Stainless- Steel	Open and hidden
HTD-12	Brass Alloy(62%Cu)	Open and hidden
HTD-12P	Stainless- Steel	Open and hidden

Available sockets :

45 Type

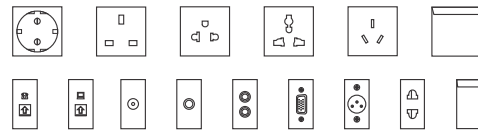

118 Type



Outline Drawing:

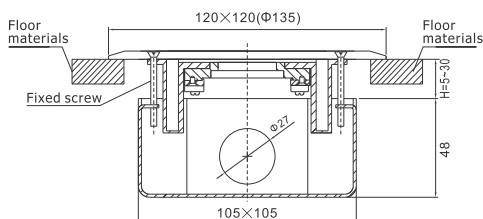

F. G. H>30mm can use longer fixing screws.



▲Temporary lid
Secure to box body during concrete pour
to prevent ingress of slurry.

▲Base box
Ga-Steel box body:105x105x48mm

OPEN COVER TYPE FLOOR SOCKET

Floor socket / Table socket / Waterproof socket



HTD-1102



HTD-1102 Cu-alloy



HTD-1102P SUS



HTD-1103 Cu-alloy



HTD-1103P SUS

HTD-1103

HTD-1102/1103 Floor Boxes Series

Basic Parameter:

Panel Dimension:	1102(211×120mm);1103(302×120mm)
Panel Material:	Brass alloy & Stainless-Steel
Finishing:	Wire drawing/Polishing / Spray painting
Interface size:	1102(6 Modules);1103(9 Modules)
Bracket Material:	Zinc Alloy & Alu Alloy
Basebox material:	Steel+Zinc plated

▲For special requirements & OEM/ODM service, please consult us.

Product specifications:

Part Number	Panel Material	Open style
HTD-1102	Brass Alloy(62%Cu)	Open and hidden
HTD-1102P	Stainless- Steel	Open and hidden
HTD-1103	Brass Alloy(62%Cu)	Open and hidden
HTD-1103P	Stainless- Steel	Open and hidden

Available sockets :

45 Type

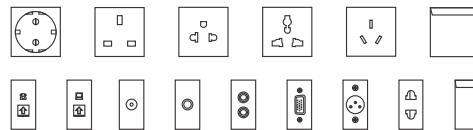

118 Type



◊Please check all kinds of sockets refer to page 45-46.

Outline Drawing:

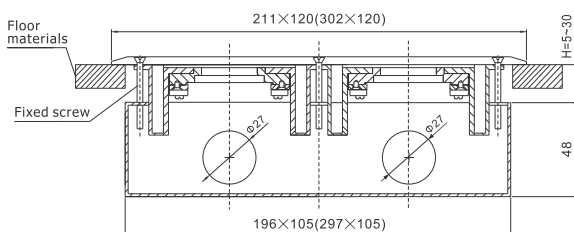

F. G. H>30mm can use longer fixing screws.



▲Temporary lid
Secure to box body during concrete pour to prevent ingress of slurry.

▲Base box
HTD-1102
Ga-Steel box body:196x105x48mm



▲Temporary lid
Secure to box body during concrete pour to prevent ingress of slurry.

▲Base box
HTD-1103
Ga-Steel box body:297x105x48mm

OPEN COVER TYPE FLOOR SOCKET

Floor socket / Table socket / Waterproof socket

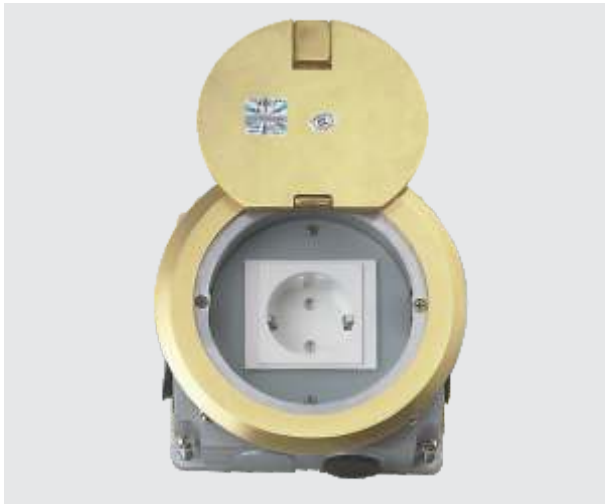

HTD-140K Floor Boxes Series

Basic Parameter:

Panel Dimension:	140×140mm
Panel Material:	Brass alloy & Stainless-Steel
Finishing:	Wire drawing/Polishing / Spray painting
Interface size:	2 Modules
Bracket Material:	Zinc Alloy & Alu Alloy
Basebox material:	Steel+Zinc plated

▲For special requirements & OEM/ODM service, please consult us.

Product specifications:

Part Number	Panel Material	Open style
HTD-140K	Brass Alloy(62%Cu)	Open and hidden
HTD-140KP	Stainless- Steel	Open and hidden



HTD-140YK



HTD-140YKP



HTD-140FK



HTD-140FNKP



HTD-140BK



HTD-140BNKP

Available sockets :

45 Type

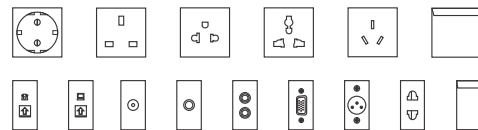

118 Type



◇Please check all kinds of sockets refer to page 45-46.

Outline Drawing:

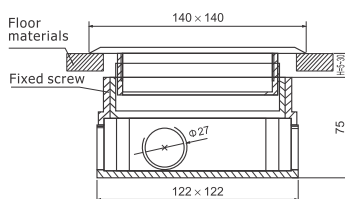

F. G. H>30mm can use longer fixing screws.



120 × 122 × 75mm

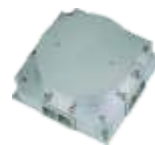

160 × 160 × 75mm

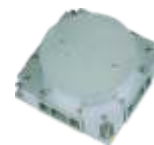

160 × 160 × 75mm

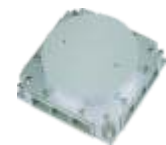

160 × 160 × 75mm

▲Temporary lid
 Secure to box body during concrete pour to prevent ingress of slurry.



OPEN COVER TYPE FLOOR SOCKET

Floor socket / Table socket / Waterproof socket



HTD-101 Cu-alloy

HTD-101P SUS

HTD-101/102 Floor Boxes Series

Basic Parameter:

Panel Dimension:	101(81×102mm);102(147×102mm)
Panel Material:	Brass alloy & Stainless-Steel
Finishing:	Wire drawing/Polishing / Spray painting
Interface size:	101(2 Modules);102(4 Modules)
Bracket Material:	Zinc Alloy & Alu Alloy
Basebox material:	Steel+Zinc plated

▲For special requirements & OEM/ODM service, please consult us.

Product specifications:

Part Number	Panel Material	Open style
HTD-101	Brass Alloy(62%Cu)	Open and hidden
HTD-101P	Stainless- Steel	Open and hidden
HTD-102	Brass Alloy(62%Cu)	Open and hidden
HTD-102P	Stainless- Steel	Open and hidden



HTD-11
Cu-alloy



HTD-12P
SUS

Available sockets :

45 Type

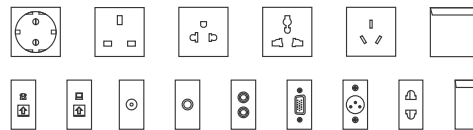

118 Type



◁Please check all kinds of sockets refer to page 45-46.

Outline Drawing:



▲Temporary lid
Secure to box body during concrete pour to prevent ingress of slurry.
▲Base box
HTD-101
Ga-Steel box body:74.3x77x50mm



▲Temporary lid
Secure to box body during concrete pour to prevent ingress of slurry.
▲Base box
HTD-102
Ga-Steel box body:134.5x77x50mm

OPEN COVER TYPE FLOOR SOCKET

Floor socket / Table socket / Waterproof socket



HTD-120K Floor Boxes Series

Basic Parameter:

Panel Dimension:	120×120mm
Panel Material:	Brass alloy & Stainless-Steel
Finishing:	Wire drawing/Polishing / Spray painting
Interface size:	3 Modules
Bracket Material:	Zinc Alloy & Alu Alloy
Basebox material:	Steel+Zinc plated

▲For special requirements & OEM/ODM service, please consult us.

Part specifications:

Part Number	Panel Material	Open style
HTD-120K	Brass Alloy(62%Cu)	Open cover
HTD-120KP	Stainless-Alloy	Open cover
HTD-120NK	Brass Alloy(62%Cu)	Open cover
HTD-120NKP	Stainless-Alloy	Open cover
HTD-120HK	Brass Alloy(62%Cu)	Open cover
HTD-120HKP	Stainless-Alloy	Open cover



HTD-120HK Cu-alloy



HTD-120NKP SUS

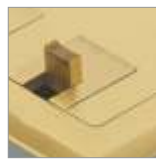

HK cable exit
Code:HK



Mounting ST optical
fiber As photo



Mounting SC optical
fiber As photo

Available sockets :

45 Type

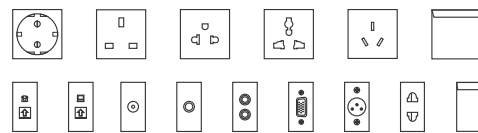

118 Type



Outline Drawing:

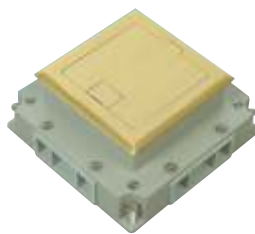

Junction box
HTD-701FX
160×160×75mm

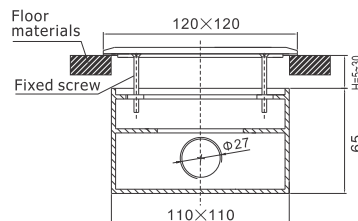

F. G. H>30mm can use longer fixing screws.



- ▲ Temporary lid
Secure to box body during concrete pour to prevent ingress of slurry.
- ▲ Base box
Ga-Steel box body:110x110x65mm

OPEN COVER TYPE FLOOR SOCKET

Floor socket / Table socket / Waterproof socket



HTD-146K Floor Boxes Series

Basic Parameter:

Panel Dimension:	146×146mm
Panel Material:	Brass alloy & Stainless-Steel
Finishing:	Wire drawing/Polishing / Spray painting
Interface size:	6 Modules
Bracket Material:	Zinc Alloy & Alu Alloy
Basebox material:	Steel+Zinc plated

▲For special requirements & OEM/ODM service, please consult us.

Part specifications:

Part Number	Panel Material	Open style
HTD-146K	Brass Alloy(62%Cu)	Open cover
HTD-146KP	Stainless-Alloy	Open cover
HTD-146NK	Brass Alloy(62%Cu)	Open cover
HTD-146NKP	Stainless-Alloy	Open cover
HTD-146DK	Brass Alloy(62%Cu)	Open cover
HTD-146DKP	Stainless-Alloy	Open cover
HTD-146HK	Brass Alloy(62%Cu)	Open cover
HTD-146HKP	Stainless-Alloy	Open cover



HTD-146HK Cu-alloy



HTD-146NKP SUS



DK cable exit
Code:DK



HK cable exit
Code:HK



Mounting ST optical
fiber As photo

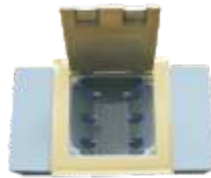

Mounting SC optical
fiber As photo

Available sockets :

45 Type

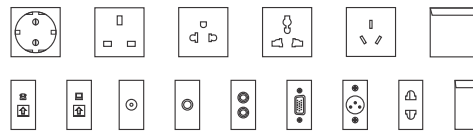

118 Type



◊Please check all kinds of sockets refer to page 45-46.

Outline Drawing:



HTD-146HK

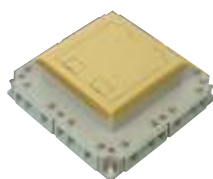

Junction box
HTD-702FX
204×204×75mm

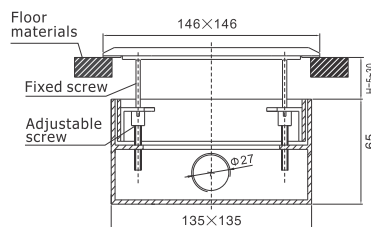

F. G. H>30mm can use longer fixing screws.



▲Temporary lid
Secure to box body during concrete
pour to prevent ingress of slurry.

▲Base box
Ga-Steel box body:135x135x65mm

OPEN COVER TYPE FLOOR SOCKET

Floor socket / Table socket / Waterproof socket



HTD-180K



HTD-180K Cu-alloy



HTD-180NKP SUS



HTD-180AK

Cover middle with 20mm concavity
Concave side can be filled with flooring.



HTD-180ANK Cu-alloy



HTD-180ANKP SUS

HTD-180K Floor Boxes Series

Basic Parameter:

Panel Dimension:	180×180mm
Panel Material:	Brass alloy & Stainless-Steel
Finishing:	Wire drawing/Polishing / Spray painting
Interface size:	10 Modules
Bracket Material:	Zinc Alloy & Alu Alloy
Basebox material:	Steel+Zinc plated

▲For special requirements & OEM/ODM service, please consult us.

Part specifications:

Part Number		Panel Material
HTD-180K	HTD-180AK	Brass Alloy(62%Cu)
HTD-180KP	HTD-180AKP	Stainless-Steel
HTD-180NK	HTD-180ANK	Brass Alloy(62%Cu)
HTD-180NKP	HTD-180ANKP	Stainless-Steel
HTD-180DK	HTD-180ADK	Brass Alloy(62%Cu)
HTD-180DKP	HTD-180ADKP	Stainless-Steel
HTD-180HK	HTD-180AHK	Brass Alloy(62%Cu)
HTD-180HKP	HTD-180AHKP	Stainless-Steel

HTD-180K/180AK Panel can be made flat edge

Available sockets :

45 Type

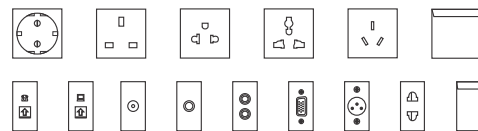

118 Type



Outline Drawing:

HTD-180K

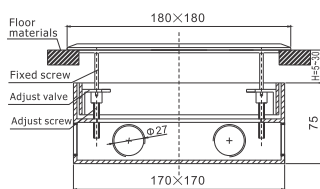

F. G. H>30mm can use longer fixing screws.



- ▲Temporary lid
Secure to box body during concrete pour to prevent ingress of slurry.
- ▲Base box
Ga-Steel box body:170x170x75mm

HTD-180AK

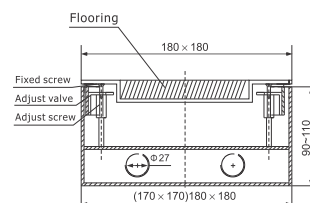

F. G. H>30mm can use longer fixing screws.



- ▲Temporary lid
Secure to box body during concrete pour to prevent ingress of slurry.
- ▲Base box
Ga-Steel box body:170x170x90mm



OPEN COVER TYPE FLOOR SOCKET

Floor socket / Table socket / Waterproof socket



HTD-210K



HTD-210K Cu-alloy



HTD-210NKP SUS



HTD-210AK



HTD-210ANK Cu-alloy



HTD-210ANKP SUS

Cover middle with 20mm concavity
Concave side can be filled with flooring.

HTD-210K Floor Boxes Series

Basic Parameter:

Panel Dimension:	210×210mm
Panel Material:	Brass alloy & Stainless-Steel
Finishing:	Wire drawing/Polishing / Spray painting
Interface size:	15 Modules
Bracket Material:	Zinc Alloy & Alu Alloy
Basebox material:	Steel+Zinc plated

▲For special requirements & OEM/ODM service, please consult us.

Part specifications:

Part Number		Panel Material
HTD-210K	HTD-210AK	Brass Alloy(62%Cu)
HTD-210KP	HTD-210AKP	Stainless-Steel
HTD-210NK	HTD-210ANK	Brass Alloy(62%Cu)
HTD-210NKP	HTD-210ANKP	Stainless-Steel
HTD-210DK	HTD-210ADK	Brass Alloy(62%Cu)
HTD-210DKP	HTD-210ADKP	Stainless-Steel
HTD-210HK	HTD-210AHK	Brass Alloy(62%Cu)
HTD-210HKP	HTD-210AHKP	Stainless-Steel

HTD-210K/210AK Panel can be made flat edge

Available sockets :

45 Type

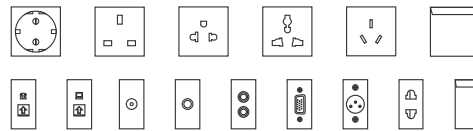

118 Type



◊Please check all kinds of sockets refer to page 45-46.

Outline Drawing:

HTD-210K

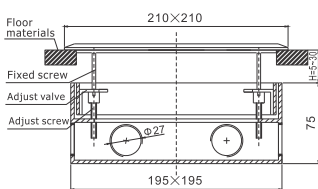

F. G. H>30mm can use longer fixing screws.



- ▲Temporary lid
Secure to box body during concrete pour to prevent ingress of slurry.
- ▲Base box
Ga-Steel box body:195x195x75mm

HTD-210AK

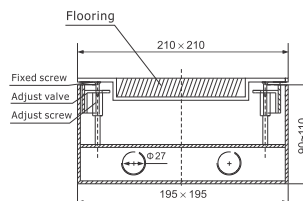

F. G. H>30mm can use longer fixing screws.

- ▲Temporary lid
Secure to box body during concrete pour to prevent ingress of slurry.
- ▲Base box
Ga-Steel box body:195x195x90mm

OPEN COVER TYPE FLOOR SOCKET

Floor socket / Table socket / Waterproof socket



HTD-250K



HTD-250K Cu-alloy



HTD-250NKP SUS



HTD-250AK

Cover middle with 20mm concavity
Concave side can be filled with flooring.



HTD-250ANK Cu-alloy



HTD-250ANKP SUS

HTD-250K Floor Boxes Series

Basic Parameter:

Panel Dimension:	250×250mm
Panel Material:	Brass alloy & Stainless-Steel
Finishing:	Wire drawing/Polishing / Spray painting
Interface size:	18 Modules
Bracket Material:	Zinc Alloy & Alu Alloy
Basebox material:	Steel+Zinc plated

▲For special requirements & OEM/ODM service, please consult us.

Part specifications:

Part Number		Panel Material
HTD-250K	HTD-250AK	Brass Alloy(62%Cu)
HTD-250KP	HTD-250AKP	Stainless-Steel
HTD-250NK	HTD-250ANK	Brass Alloy(62%Cu)
HTD-250NKP	HTD-250ANKP	Stainless-Steel
HTD-250DK	HTD-250ADK	Brass Alloy(62%Cu)
HTD-250DKP	HTD-250ADKP	Stainless-Steel
HTD-250HK	HTD-250AHK	Brass Alloy(62%Cu)
HTD-250HKP	HTD-250AHKP	Stainless-Steel

HTD-250K/250AK Panel can be made flat edge

Available sockets :

45 Type

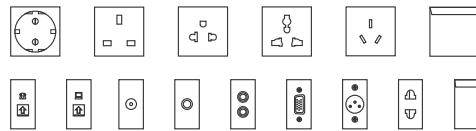

118 Type



◇Please check all kinds of sockets refer to page 45-46.

Outline Drawing:

HTD-250K

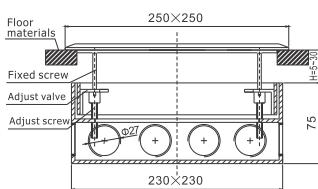

F. G. H>30mm can use longer fixing screws.



- ▲Temporary lid
Secure to box body during concrete pour to prevent ingress of slurry.
- ▲Base box
Ga-Steel box body:230x230x75mm

HTD-250AK

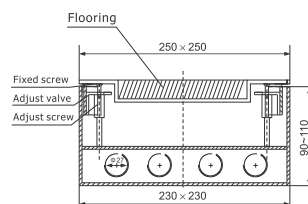

F. G. H>30mm can use longer fixing screws.



- ▲Temporary lid
Secure to box body during concrete pour to prevent ingress of slurry.
- ▲Base box
Ga-Steel box body:230x230x90mm

OPEN COVER TYPE FLOOR SOCKET

Floor socket / Table socket / Waterproof socket

HTD-2242K/2702K Floor Boxes Series

Basic Parameter:

Panel Dimension:	2242K(224×120mm);2702K(270×146mm)
Panel Material:	Brass alloy & Stainless-Steel
Finishing:	Wire drawing/Polishing / Spray painting
Interface size:	2242K(6 Modules);2702K(12 Modules)
Bracket Material:	Zinc Alloy & Alu Alloy
Basebox material:	Steel+Zinc plated

▲For special requirements & OEM/ODM service, please consult us.

Part specifications:

Part Number	Panel Material	
HTD-2242K	HTD-2702K	Brass Alloy(62%Cu)
HTD-2242KP	HTD-2702KP	Stainless-Steel
HTD-2242NK	HTD-2702NK	Brass Alloy(62%Cu)
HTD-2242NKP	HTD-2702NKP	Stainless-Steel
HTD-2242HK	HTD-2702DK	Brass Alloy(62%Cu)
HTD-2242HKP	HTD-2702DKP	Stainless-Steel
	HTD-2702HK	Brass Alloy(62%Cu)
	HTD-2702HKP	Stainless-Steel



HTD-2242K



HTD-2242K Cu-alloy



HTD-2242NKP SUS



HTD-2702K



HTD-2702K Cu-alloy



HTD-2702NKP SUS

Available sockets :

45 Type

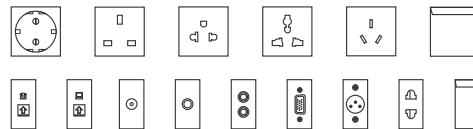

118 Type



◊Please check all kinds of sockets refer to page 45-46.



DK cable exit
Code:DK



HK cable exit
Code:HK

Outline Drawing:

HTD-2242K

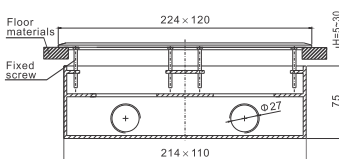

F. G. H>30mm can use longer fixing screws.



▲ Temporary lid
Secure to box body during concrete pour to prevent ingress of slurry.

▲ Base box
Ga-Steel box body:214x110x75mm

HTD-2702K

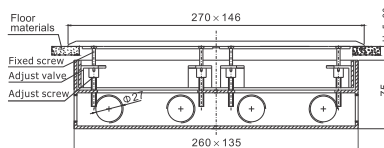

F. G. H>30mm can use longer fixing screws.



▲ Temporary lid
Secure to box body during concrete pour to prevent ingress of slurry.

▲ Base box
Ga-Steel box body:260x135x75mm

OPEN COVER TYPE FLOOR SOCKET

Floor socket / Table socket / Waterproof socket



HTD-300K



HTD-300K Cu-alloy



HTD-300NKP SUS

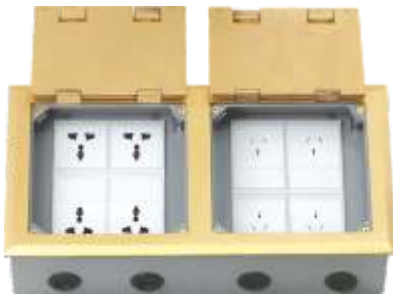

HTD-3402K



HTD-3402K Cu-alloy



HTD-3402NKP SUS



DK cable exit
Code:DK



HK cable exit
Code:HK

HTD-300K/3402K Floor Boxes Series

Basic Parameter:

Panel Dimension:	300K(300×150mm);3402K(340×180mm)
Panel Material:	Brass alloy & Stainless-Steel
Finishing:	Wire drawing/Polishing / Spray painting
Interface size:	300K(12 Modules);3402K(20 Modules)
Bracket Material:	Zinc Alloy & Alu Alloy
Basebox material:	Steel+Zinc plated

▲For special requirements & OEM/ODM service, please consult us.

Part specifications:

Part Number		Panel Material
HTD-300K	HTD-3402K	Brass Alloy(62%Cu)
HTD-300KP	HTD-3402KP	Stainless-Steel
HTD-300NK	HTD-3402NK	Brass Alloy(62%Cu)
HTD-300NKP	HTD-3402NKP	Stainless-Steel
HTD-300DK	HTD-3402DK	Brass Alloy(62%Cu)
HTD-300DKP	HTD-3402DKP	Stainless-Steel
HTD-300HK	HTD-3402HK	Brass Alloy(62%Cu)
HTD-300HKP	HTD-3402HKP	Stainless-Steel

Available sockets :

45 Type

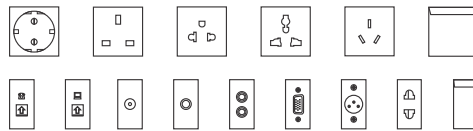

118 Type



Outline Drawing:

HTD-300K

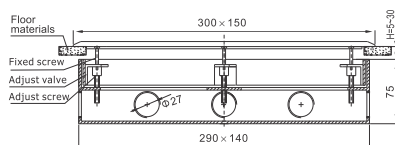

F. G. H>30mm can use longer fixing screws.



- ▲ Temporary lid
Secure to box body during concrete pour to prevent ingress of slurry.
- ▲ Base box
Ga-Steel box body:290x140x75mm

HTD-3402K

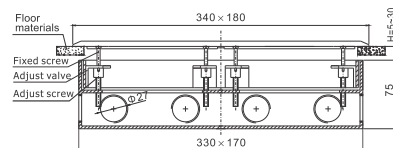

F. G. H>30mm can use longer fixing screws.



- ▲ Temporary lid
Secure to box body during concrete pour to prevent ingress of slurry.
- ▲ Base box
Ga-Steel box body:330x170x75mm

OPEN COVER TYPE FLOOR SOCKET

Floor socket / Table socket / Waterproof socket



HTD-210CK



HTD-210CK Cu-alloy



HTD-210CKNP SUS

HTD-210CK/251CK Floor Boxes Series

Basic Parameter:

Panel Dimension:	210CK(210×210mm); 251CK(250×180mm)
Panel Material:	Brass alloy & Stainless-Steel
Finishing:	Wire drawing/Polishing / Spray painting
Interface size:	210CK(10 Modules); 251CK(10 Modules)
Bracket Material:	Zinc Alloy & Alu Alloy
Basebox material:	Steel+Zinc plated

▲For special requirements & OEM/ODM service, please consult us.

Part specifications:

Part Number		Panel Material
HTD-210CK	HTD-251CK	Brass Alloy(62%Cu)
HTD-210CKP	HTD-251CKP	Stainless-Steel
HTD-210CNK	HTD-251CNK	Brass Alloy(62%Cu)
HTD-210CKNP	HTD-251CKNP	Stainless-Steel
HTD-210CDK	HTD-251CDK	Brass Alloy(62%Cu)
HTD-210CDKP	HTD-251CDKP	Stainless-Steel
HTD-210CHK	HTD-251CHK	Brass Alloy(62%Cu)
HTD-210CHKP	HTD-251CHKP	Stainless-Steel



HTD-251CK



HTD-251CK Cu-alloy



HTD-251CKP SUS

Available sockets :

45 Type

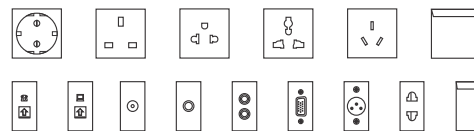

118 Type



◊Please check all kinds of sockets refer to page 45-46.

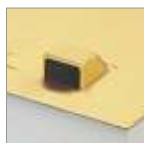

DK cable exit
Code:DK



HK cable exit
Code:HK

Outline Drawing:

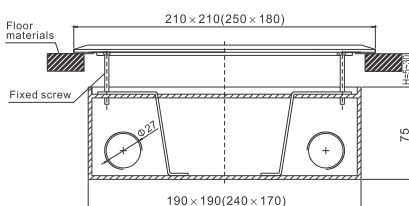

F. G. H > 30mm can use longer fixing screws.



HTD-210CK

▲Temporary lid
Secure to box body during concrete pour to prevent ingress of slurry.

▲Base box
Ga-Steel box body: 190x190x75mm



HTD-251CK

▲Temporary lid
Secure to box body during concrete pour to prevent ingress of slurry.

▲Base box
Ga-Steel box body: 240x170x75mm

OPEN COVER TYPE FLOOR SOCKET

Floor socket / Table socket / Waterproof socket



HTD-145K



HTD-145K Cu-alloy



HTD-145KP SUS

HTD-302AL

DK cable exit
Code:DK



HTD-302AL Alu alloy



Cover middle with 8 mm concavity,
Concave side can be filled with flooring.

HTD-145K/302AL Floor Boxes Series

Basic Parameter:

Panel Dimension:	145K(210×145mm);302AL(210×140mm)
Panel Material:	Brass alloy & Stainless-Steel
Finishing:	Wire drawing/Polishing / Spray painting
Interface size:	145K(8 Modules);302AL(6 Modules)
Bracket Material:	Zinc Alloy & Alu Alloy
Basebox material:	Steel+Zinc plated

▲For special requirements & OEM/ODM service, please consult us.

Part specifications:

Part Number	Panel Material	Open style
HTD-145K	Brass Alloy(62%Cu)	Open cover
HTD-145KP	Stainless-Steel	Open cover
HTD-145NK	Brass Alloy(62%Cu)	Open cover
HTD-145NKP	Stainless-Steel	Open cover
HTD-145DK	Brass Alloy(62%Cu)	Open cover
HTD-145DKP	Stainless-Steel	Open cover
HTD-145HK	Brass Alloy(62%Cu)	Open cover
HTD-145HKP	Stainless-Steel	Open cover

Available sockets :

45 Type

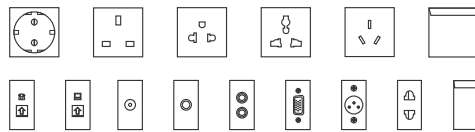

118 Type



◇Please check all kinds of sockets refer to page 45-46.

Outline Drawing:

HTD-302AL

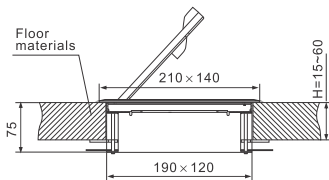

F. G. H>30mm can use longer fixing screws.



▲Temporary lid
Secure to box body during concrete pour to prevent ingress of slurry.

▲Base box
Ga-Steel box body:190x120x75mm

HTD-145K

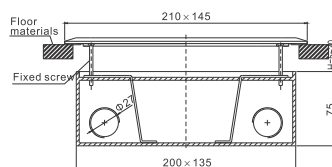

F. G. H>30mm can use longer fixing screws.

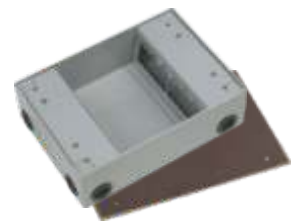

▲Temporary lid
Secure to box body during concrete pour to prevent ingress of slurry.

▲Base box
Ga-Steel box body:200x135x75mm

PLASTIC TYPE FLOOR SOCKET

FINE WORKMANSHIP MAKE
Competitive Floor Socket



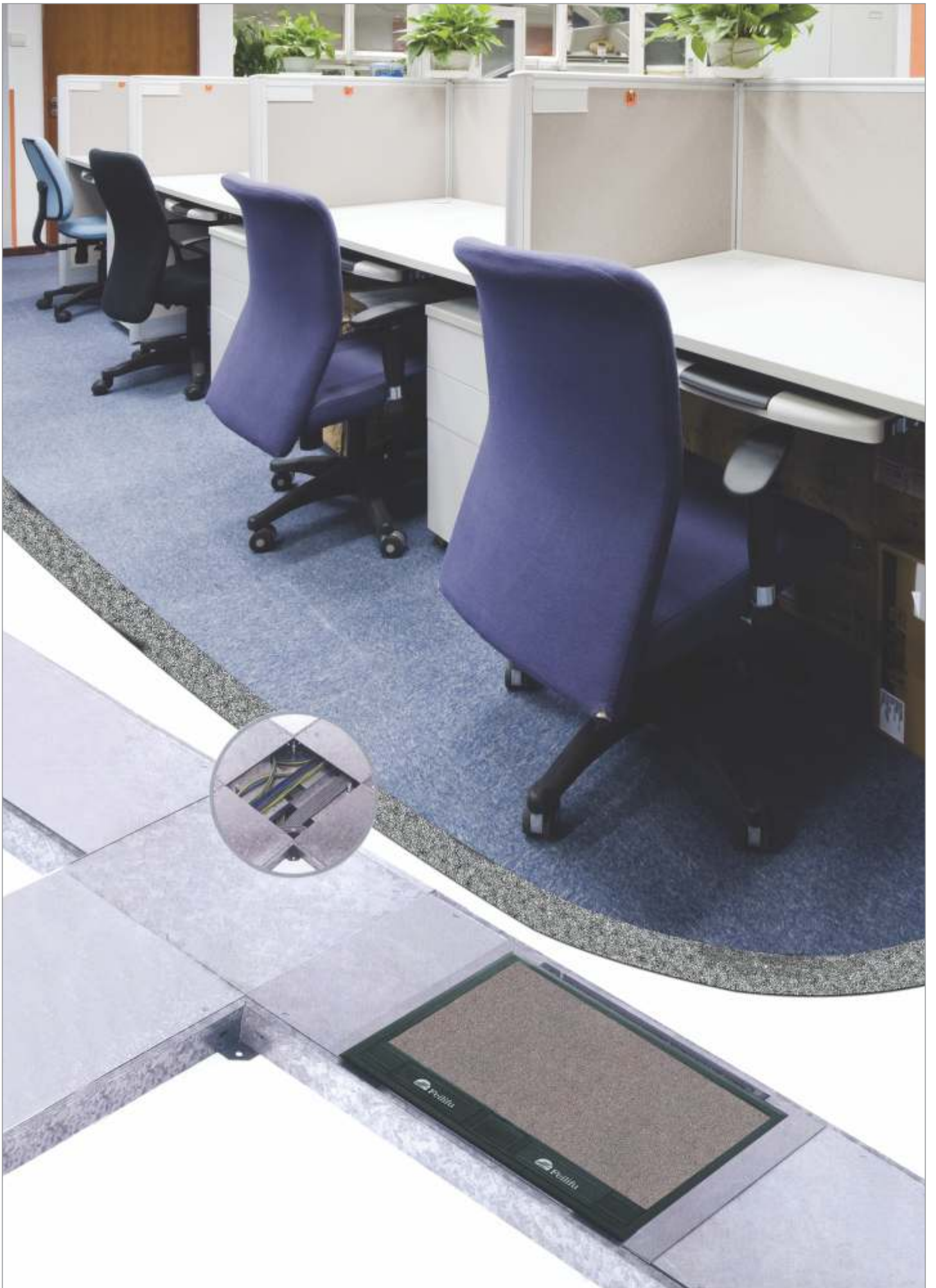



Plastic Type Floor Socket

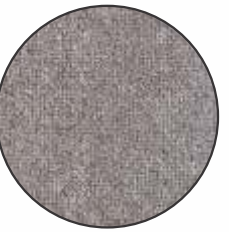
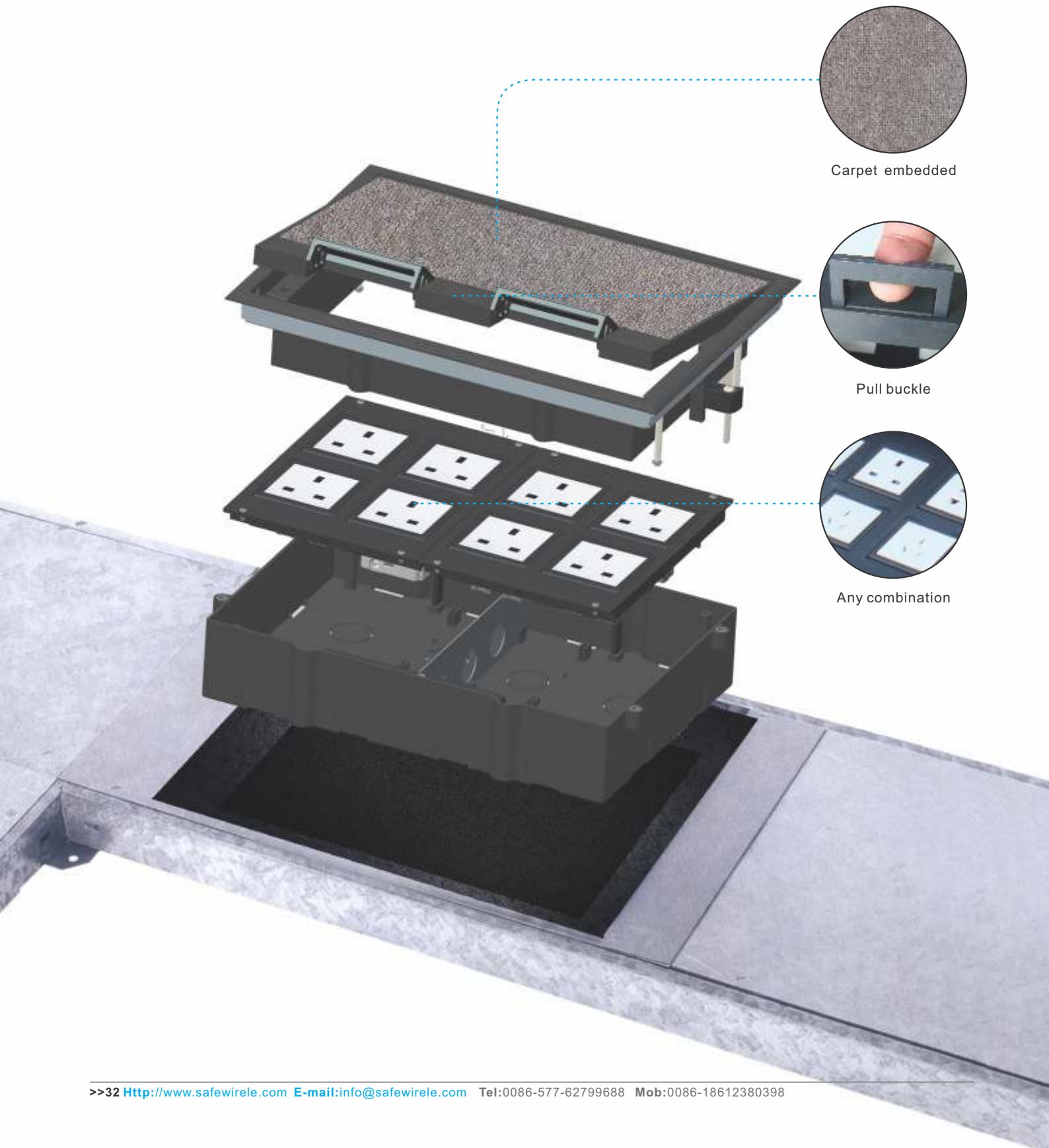

Carpet embedded



Pull buckle

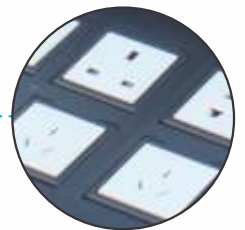

Any combination

PLASTIC TYPE FLOOR SOCKET

Floor socket / Table socket / Waterproof socket



HTD-622AS Floor Boxes Series

Basic Parameter:

Panel Dimension:	169×141.5mm
Basebox Dimension:	126×110.5×70mm
Panel Material:	Plastic
Interface size:	8 Modules
Basebox material:	Plastic

▲For special requirements & OEM/ODM service, please consult us.

Available sockets :

45 Type

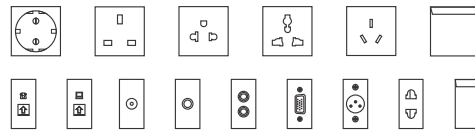

◊Please check all kinds of sockets refer to page 49-50.



HTD- 622AS
Cover middle can be filled



HTD- 622SS
Filled with Plastic plate



HTD- 622SP
Filled with SUS plate

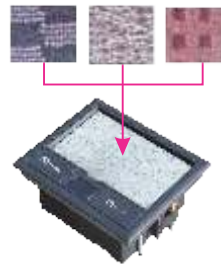

HTD- 622AS
Cover middle with 8mm concavity
Concave side can be filled with flooring.

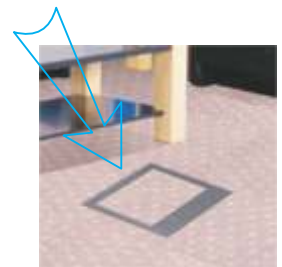

HTD- 622AS
Simulationsbild
installed on
carpet

Outline Drawing:

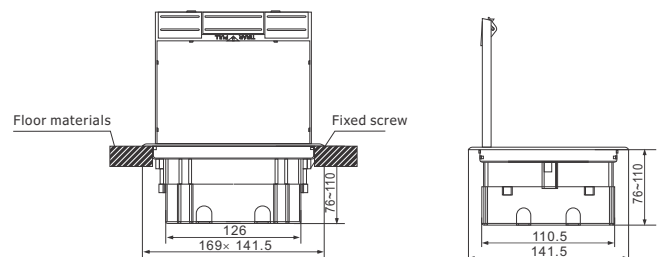

F. G. H>30mm can use longer fixing screws.

PLASTIC TYPE FLOOR SOCKET

Floor socket / Table socket / Waterproof socket



HTD-624AS Floor Boxes Series

Basic Parameter:

Panel Dimension:	245×225mm
Basebox Dimension:	189.5×189.5×70mm
Panel Material:	Plastic
Interface size:	12 Modules
Basebox material:	Plastic

▲For special requirements & OEM/ODM service, please consult us.

Available sockets :

45 Type

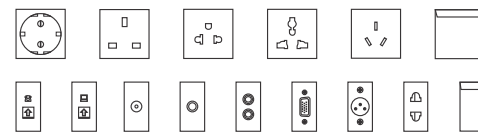

◊Please check all kinds of sockets refer to page 49-50.



Function can be side mount



HTD- 624AS
Cover middle with 8mm concavity
Concave side can be filled with flooring.

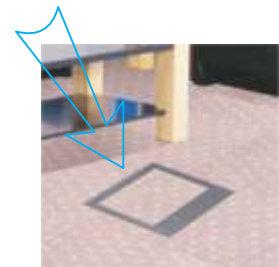

HTD- 624AS
Simulationsbild
installed on
carpet



HTD- 624AS
Cover middle can be filled



HTD- 624SS
Filled with Plastic plate



HTD- 624SP
Filled with SUS plate

Outline Drawing:

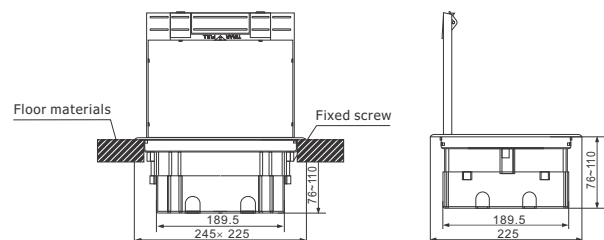

F. G. H>30mm can use longer fixing screws.

PLASTIC TYPE FLOOR SOCKET

Floor socket / Table socket / Waterproof socket



HTD-626AS Floor Boxes Series

Basic Parameter:

Panel Dimension:	320.5×230.5mm
Basebox Dimension:	303.5×213.5×95mm
Panel Material:	Plastic
Interface size:	16 Modules
Basebox material:	Steel

▲For special requirements & OEM/ODM service, please consult us.

Available sockets :

45 Type

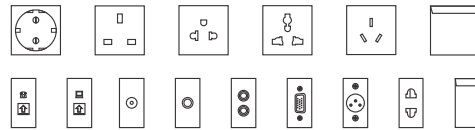

◇Please check all kinds of sockets refer to page 49-50.



HTD- 626AS
Cover middle can be filled



HTD- 626SS
Filled with Plastic plate



HTD- 626SP
Filled with SUS plate

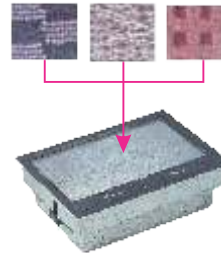

HTD- 626AS
Cover middle with 8mm concavity
Concave side can be filled with flooring.

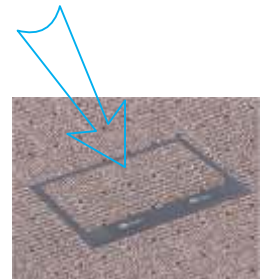

HTD- 626AS
Simulationsbild
installed on
carpet

Outline Drawing:

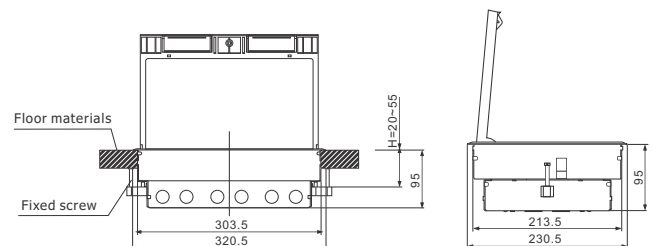

F. G. H>30mm can use longer fixing screws.

PLASTIC TYPE FLOOR SOCKET

Floor socket / Table socket / Waterproof socket



HTD-628AS Floor Boxes Series

Basic Parameter:

Panel Dimension:	328×230.5mm
Basebox Dimension:	279.5×189.5×95mm
Panel Material:	Plastic
Interface size:	16 Modules
Basebox material:	Plastic

▲For special requirements & OEM/ODM service, please consult us.

Available sockets :

45 Type

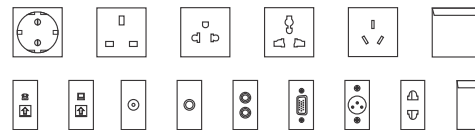

◊Please check all kinds of sockets refer to page 49-50.



HTD- 628AS

Cover middle can be filled



HTD- 628SS

Filled with Plastic plate

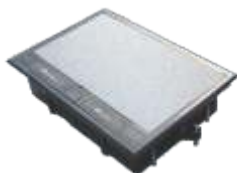

HTD- 628SP

Filled with SUS plate



HTD- 628AS

Cover middle with 8mm concavity
 Concave side can be filled with flooring.

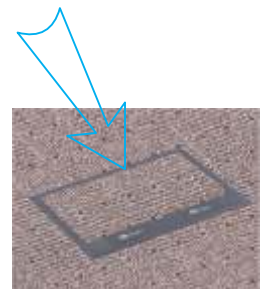

HTD- 628AS

Simulationsbild
 installed on
 carpet

Outline Drawing:

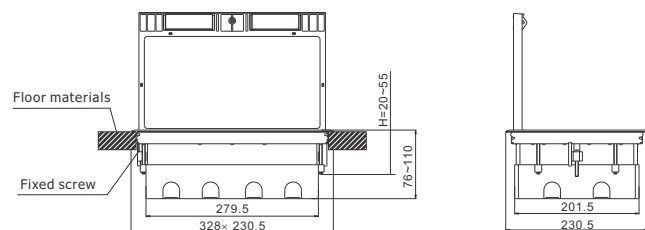

F. G. H>30mm can use longer fixing screws.

SWIVEL TYPE FLOOR SOCKET

Floor socket / Table socket / Waterproof socket



HTD-160 Floor Boxes Series

Basic Parameter:

Panel Dimension:	Φ160mm
Panel Material:	Brass alloy & Stainless-Steel
Finishing:	Wire drawing/Polishing / Spray painting
Interface size:	3 Modules
Bracket Material:	Zinc Alloy & Alu Alloy
Basebox material:	Steel

▲For special requirements & OEM/ODM service, please consult us.

Available sockets :

45 Type

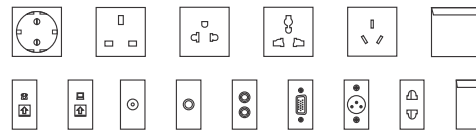

◊Please check all kinds of sockets refer to page 49-50.



HTD-160LX Cu-alloy



HTD-160LXT Cu-alloy

Outline Drawing:

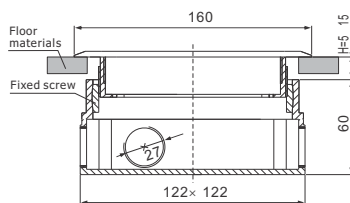

F. G. H>30mm can use longer fixing screws.



- ▲Temporary lid
Secure to box body during concrete pour to prevent ingress of slurry.
- ▲Base box
Ga-Steel box body: 145x145x60mm



SWIVEL TYPE FLOOR SOCKET

Floor socket / Table socket / Waterproof socket



HTD-127ZAP Floor Boxes Series

Basic Parameter:

Panel Dimension:	Φ127mm
Panel Material:	Stainless-Steel
Finishing:	Wire drawing/Polishing / Spray painting
Interface size:	3 Modules
Bracket Material:	Zinc Alloy & Alu Alloy
Basebox material:	Steel

▲For special requirements & OEM/ODM service, please consult us.

Available sockets :

45 Type

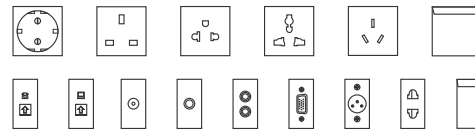

◊Please check all kinds of sockets refer to page 49-50.

Outline Drawing:

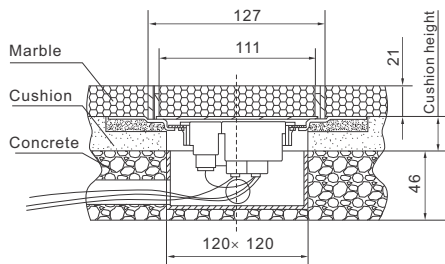

Panel Material: Stainless-Steel
 Open style: Open and hidden
 Interface size: 3 Modules

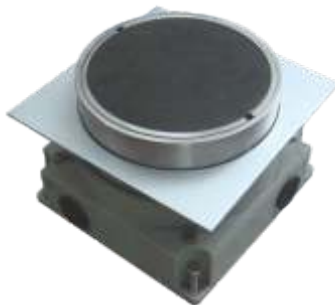

Cover middle with 20mm concavity
 Concave side can be filled with flooring.

TABLE SOCKET

Floor socket / Table socket / Waterproof socket

HTM-536 Table Socket



Basic Parameter:

Panel Dimension:	220×110mm
Panel Material:	Plastic
Finishing:	Sandblasting
Interface size:	6 module
Open style:	Pop-up
Service time:	Open/Close action/100000times

▲For special requirements & OEM/ODM service, please consult us.

Available sockets :

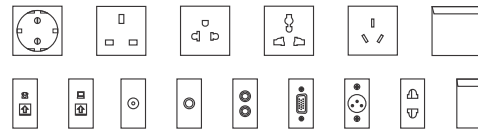
45 Type



◇Please check all kinds of sockets refer to page 49-50.

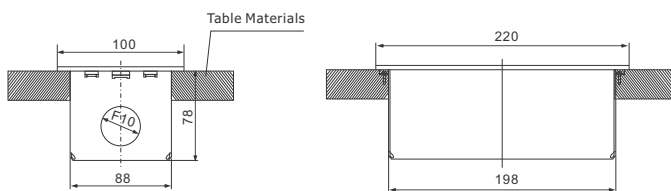

HTM- 536S

Outline Drawing:

- ▲Temporary lid
Secure to box body during concrete pour to prevent ingress of slurry.
- ▲Base box
Ga-Steel box body:198x88x78mm

TABLE SOCKET

Floor socket / Table socket / Waterproof socket



HTM-610S Table Socket

Basic Parameter:

Panel Dimension:	Φ115mm
Panel Material:	Plastic
Finishing:	Sandblasting
Interface size:	3 module
Bracket Material:	Plastic
Service time:	Open/Close action/100000times

▲For special requirements & OEM/ODM service, please consult us.

Available sockets :

45 Type

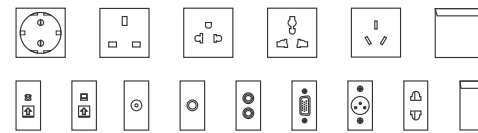

◊Please check all kinds of sockets refer to page 49-50.



HTM-610S



In service



Outline Drawing:

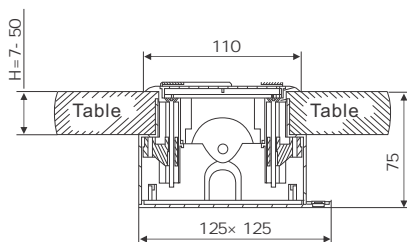

▲Temporary lid
Secure to box body during concrete pour
to prevent ingress of slurry.

▲Base box
Ga-Steel box body:125x125x75mm



Wenzhou Safewire Electric Co.,Ltd.

Office Add:No.152 Xingguang Road, Xingguang industry zone,
Liushi town, Yueqing, Wenzhou,China ,325604

Factory Add: No.18,Chunhui Rd, Yongan Industrial Zone,
Xianju County,Taizhou City,Zhejiang,China 317300 ,

Showing Room Add:J C8-112 , China Electric &Electrical Center,
Liushi town, Yueqing, Wenzhou,China ,

Tel:0086-577-62799688 **Mob:**0086-18612380398

Http://www.safewirele.com **E-mail:**info@safewirele.com



TABLE SOCKET

Floor socket / Table socket / Waterproof socket

FZ501 Series Desktop Socket



Zinc alloy panel with integrated pressure casting structure

Wire outlet, convenient and fast



Certificated socket

Closed bottom case, with beautiful structure and durable

Product features:

- Round structure, beautiful appearance;
- The material for main body uses high- quality zinc alloy for pressure casting as integration, with high intensity and it is durable;
- Surface is processed by painting, and good anticorrosion function ;
- Closed plastic bottom case is easily installed with safe use, and can use the current wire hole of the desktop.

Installation instruction

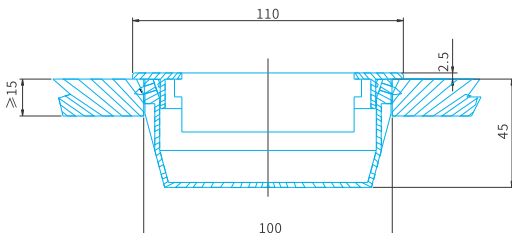

Size of bottom case: 100x 45mm

TABLE SOCKET

Floor socket / Table socket / Waterproof socket

FZ502 Series Desktop Socket



Craft

Golden edge, creating lightly
luxurious flirtatious expression

Smart

Concealed installation,
reflecting the space flexibility

Safe

Insulating materials,
integrated structure module

Intelligent

Intelligent home furnishing,
feeling different life

Product features:

- The products uses high- quality engineering plastics, and reasonable and durable structure;
- The surface uses special injection molding craft, with beautiful appearance and convenient use.



Installation instruction

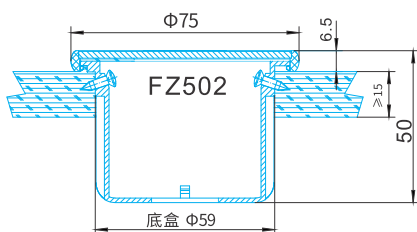

Size of bottom case: 59x 46mm



TABLE SOCKET

Floor socket / Table socket / Waterproof socket

FZ505 Series Desktop Socket



Golden edge, creating lightly
luxurious flirtatious expression



Concealed installation,
reflecting the space flexibility



USB port, optimizing
the charging experience



Insulating materials,
integrated structure module



Intelligent home furnishing,
feeling different life

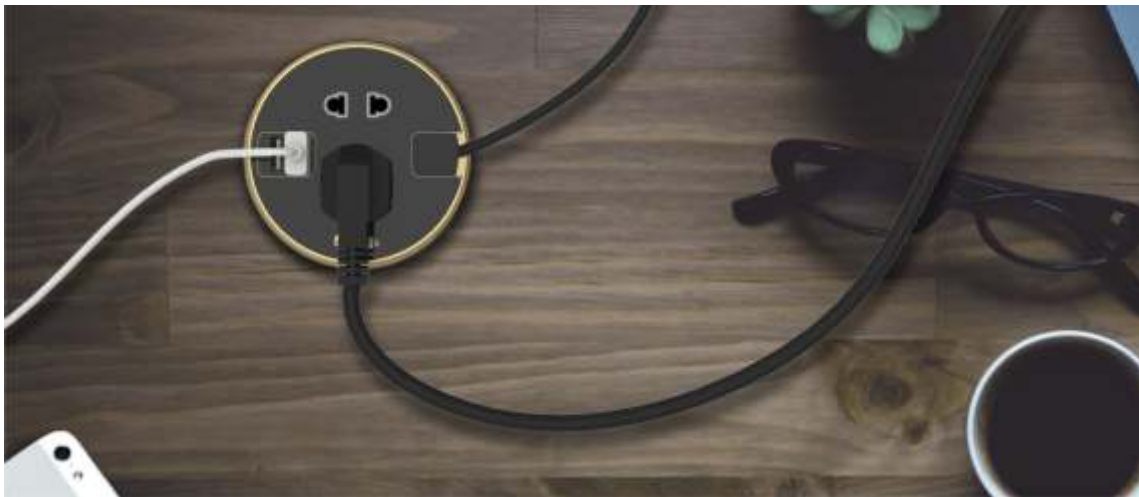

Product features:

- The products uses high- quality engineering plastics, and reasonable and durable structure;
- The surface uses special injection molding craft, with beautiful appearance and convenient use;
- Full- voltage USB smart quick charge, supporting QC3.0, carrying QUALCOMM identification chip, power conversion rate of above 80%, and at the same time, a variety of intelligent protection functions including overcharge protection, over- temperature protection, overvoltage protection, short circuit protection, under- voltage protection, overload protection, etc.

Installation instruction

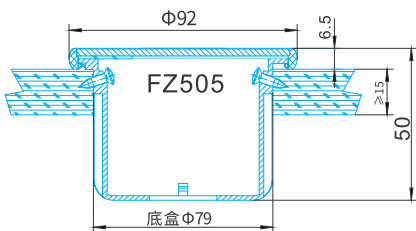

Size of bottom case: 79× 46mm



TABLE SOCKET

Floor socket / Table socket / Waterproof socket

FZ510 Series Desktop Socket

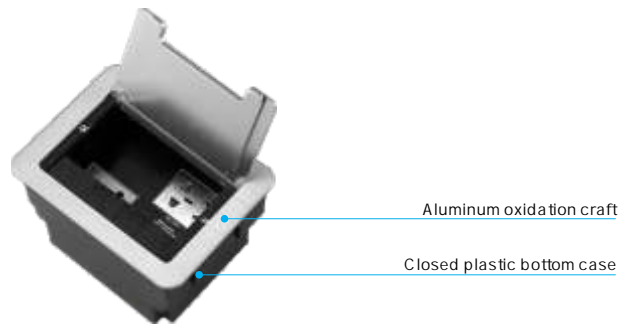
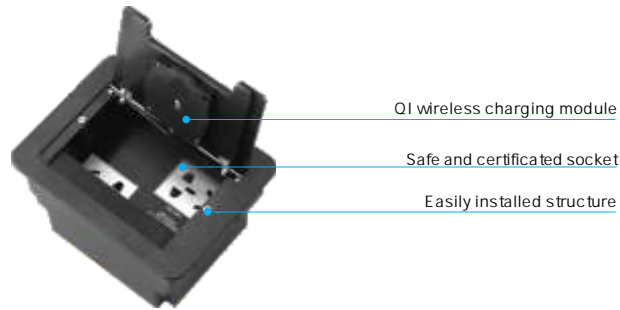

FZ510-D/ silver wire drawing oxidation



FZ510A-N/ black wire drawing oxidation



FZ510A-N/ silver wire drawing oxidation with wireless charging



FZ510N-N/ black wire drawing oxidation with wireless charging

Product features:

- Wireless charging function selection accords with the QI standard;
- Double-outlet standard USB, full-voltage USB smart quick charge, supporting QC3.0, carrying QUALCOMM identification chip, power conversion rate of above 80%, and at the same time, a variety of intelligent protection functions including overcharge protection, over-temperature protection, overvoltage protection, short circuit protection, under-voltage protection, overload protection, etc. overvoltage protection, short circuit protection, under-voltage protection, overload protection, etc.

Installation instruction

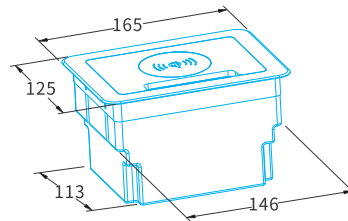
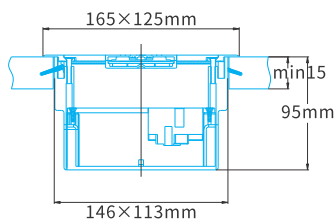

Size of bottom case: 146x113x95mm



TABLE SOCKET

Floor socket / Table socket / Waterproof socket

FZ515 Series Desktop Socket



Safe and certificated socket

Integrated mounding with aluminum alloy

Closed plastic bottom case

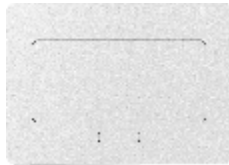

FZ515- DZ/L Silver stoving varnish

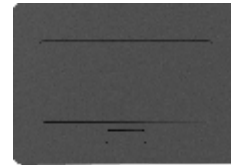

FZ515- NZ/L Black stoving varnish

Product features:

- damped structures: the product has long life of service; press the button to make the product slowly open, quiet and soft, comfortable life experience;
- Full- voltage USB smart quick charge, supporting QC3.0, carrying QUALCOMM identification chip, power conversion rate of above 80%, and at the same time, a variety of intelligent protection functions including overcharge protection, over- temperature protection, overvoltage protection, short circuit protection, under- voltage protection, overload protection, etc.

Installation instruction

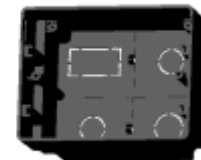
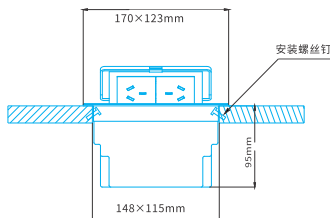

Size of bottom case: 146x113x95mm



TABLE SOCKET

Floor socket / Table socket / Waterproof socket

FZ517 Series Desktop Socket



FZ517- DZA Silver stoving varnish



FZ517- NZA Black stoving varnish



Product features:

- damped structures: the product has long life of service; press the button to make the product slowly open, quiet and soft, comfortable life experience;
- Full- voltage USB smart quick charge, supporting QC3.0, carrying QUALCOMM identification chip, power conversion rate of above 80%, and at the same time, a variety of intelligent protection functions including overcharge protection, over- temperature protection, overvoltage protection, short circuit protection, under- voltage protection, overload protection, etc.

Installation instruction

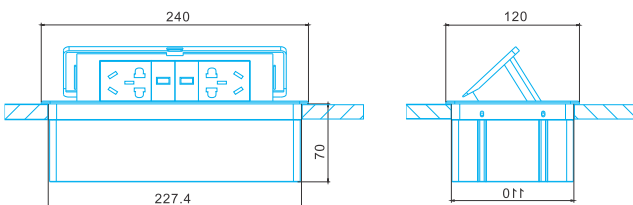

Size of bottom case: 229x110x70mm



TABLE SOCKET

Floor socket / Table socket / Waterproof socket

FZ518 Series Desktop Socket

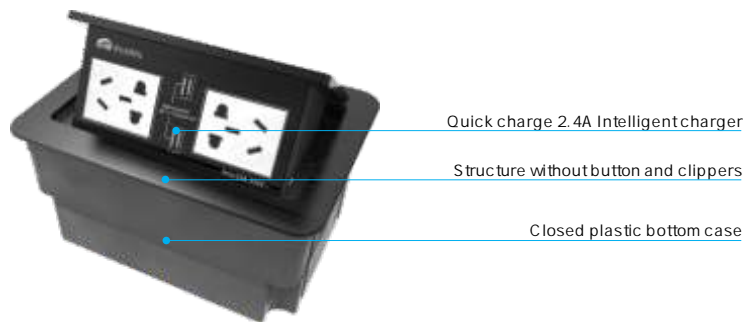
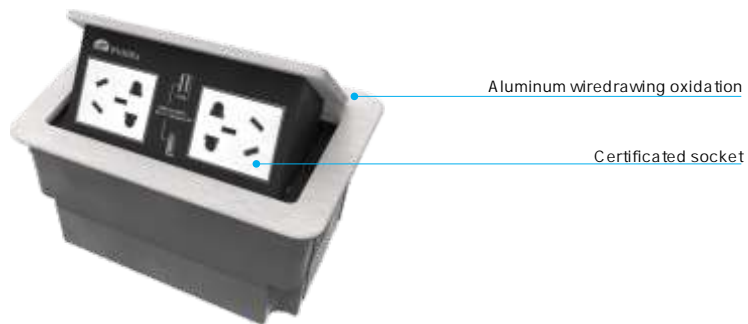

FZ518- DZ/L Silver wiredrawing oxidation

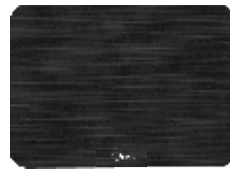

FZ518- NZ/L Black wiredrawing oxidation

Product features:

- The product uses high- quality aviation aluminum alloy CNC with integrated formation, high intensity and reasonable and resistant structure;
- The surface's wiredrawing with hard anodizing, with beautiful appearance, and elegant;
- damped structures; the product has long life of service; press the button to make the product slowly open, quiet and soft, comfortable life experience.

Installation instruction

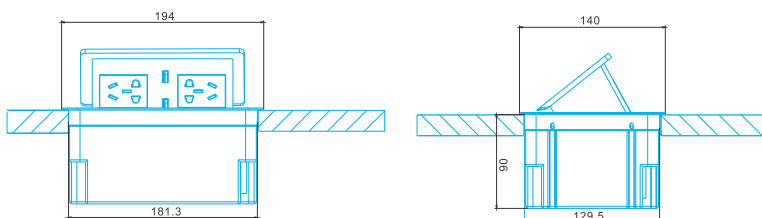

Size of bottom case: 181.3x129.5x120mm

TABLE SOCKET

Floor socket / Table socket / Waterproof socket

FZ520 Series Desktop Socket



Product features:

- The product is suitable for meeting room, office desk, executive desk, partition wall, cabinet, ceiling, display platform, home decoration, stage, etc., and effectively integrates several power sockets and multimedia elv interface on a socket, hidden under the table, so the product box body for only 80mm-diameter hole on the desktop adopts high- grade aluminum anodization, bright and beautiful. In use, its surface is easy to clean, and resistant. All functions can use the wire or jump line for information point docking. For light socket dome, dome automatically pops up 1.5 cm, and then use hand to draw the round cover plate. Pull the socket to the lower level, and insert the plug of outside wiring to the corresponding socket.

Installation instruction

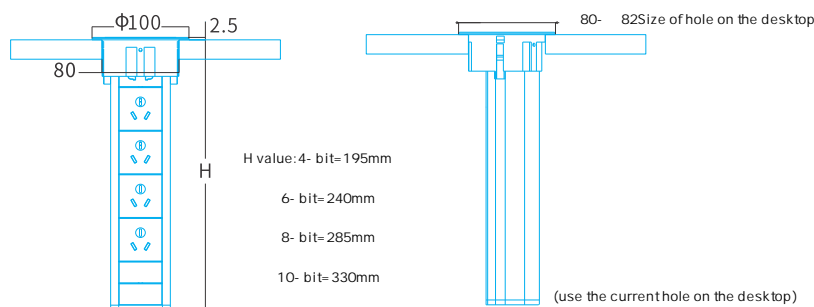



TABLE SOCKET

Floor socket / Table socket / Waterproof socket

FZ536 Series Desktop Socket



FZ536- S/ Grey plastic sand streak surface

Product features:

- Open hidden structure; in using, open the cover plate, and the whole plate is collected inside the product, which does not affect the other desktop to use;
- Embedded installation; after installation, product and desktop are at the same level, and it will not over the desktop height, blended with the desktop.

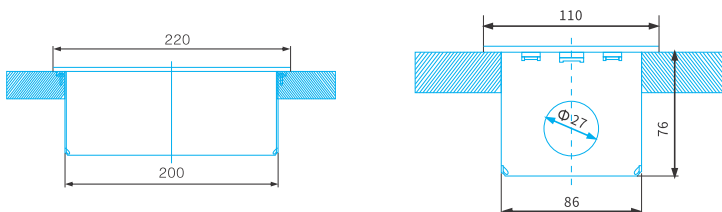

Size of bottom case: 200x86x76mm



FUNCTION ACCESSORIES

Floor socket / Table socket / Waterproof socket

45 Type Function Accessories

									
Type	2 pin socket	3 pin 10A socket	3 pin multi function	BS socket	EU socket	French socket	USA socket		
Art No.	F2	F3	F4	F11	F15	F16	F18		
									
Type	RJ45 socket	Cat.6 data socket	TEL socket	TV socket	BNC socket	φ 3.5 earphone socket	DIN(eight pins)	Audio socket	Vedio socket
Art No.	F21	F22	F23	F50	F51	F52	F53	F55	F56
									
Type	AV socket	Stereo socket	USB	Cannon socket	Speaker socket	15 pins VGA (Both sides pin type)	15 pins VGA (Both sides hole type)	15 pins VGA (Pin type)	
Art No.	F57	F58	F59	F60	F62	F63	F64	F65	
									
Type	15 pins VGA (Hole type)	9 pins VGA (Pin type)	9 pins VGA (Hole type)	HD TV socket	Empty plate	S-terminal	Small single module switch	Small dual module switch	
Art No.	F66	F67	F68	F69	F70	F71	F80	F81	
									
Type	Big single module switch	Big dual module switch	ST optical fiber module	FC optical fiber module	SC optical fiber module	2SC optical fiber module			
Art No.	F82	F83	F90	F91	F92	F93			



FUNCTION ACCESSORIES

Floor socket / Table socket / Waterproof socket

118 TYPE SOCKETS (36×36mm)



Type | 2 pin socket
Art No. | B2



Type | 3 pin socket
Art No. | B3



Type | 3 pin multifactorial socket
Art No. | B4



Type | 3 phase 4 wires 16A socket
Art No. | B5



Type | RJ45 socket
Art No. | B21



Type | Cat.6 data socket
Art No. | B22



Type | TEL socket
Art No. | B23



Type | TV socket
Art No. | B50



Type | BNC socket
Art No. | B51



Type | Φ3.5 earphone socket
Art No. | B52



Type | DIN (8 pins)
Art No. | B53



Type | Audio socket
Art No. | B55



Type | Video socket
Art No. | B56



Type | Stereo socket
Art No. | B58



Type | USB socket
Art No. | B59



Type | Cannon socket (Pin type)
Art No. | B60



Type | Cannon socket (Hole type)
Art No. | B61



Type | Speaker socket
Art No. | B62



Type | 15 pins VGA (Both sides pin type)
Art No. | B63



Type | 15 pins VGA (Both sides hole type)
Art No. | B64



Type | 15 pins VGA (Pin type)
Art No. | B65



Type | 15 pins VGA (Hole type)
Art No. | B66



Type | 9 pins VGA (Pin type)
Art No. | B67



Type | 9 pins VGA (Hole type)
Art No. | B68



Type | Twin audio socket
Art No. | B69

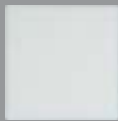

Type | Empty plate
Art No. | B70



Type | S-terminal
Art No. | B71



Type | Stage stereo
Art No. | B72